

The Makita logo is displayed in white, italicized font on a red rectangular background in the top right corner of the image.

PROMOFOLDER

01/04/2023 - 30/09/2023

NIEUWIGHEDEN

Artikel	Pagina
TD003GZ01	6
UT001GZ02	13
HS012GZ01	16
AC001GZ	22
MW001GZ	23
CW002GZ01	23
DHR183RTWJ	30
E-20236	32
DJV185RTJ	37
DJS800Z	47
VR001CZ	50
VR002CZ	50
VR003CZ	50
VR004CZ	50
DA5180Z	56
DA5180RT	56
DEABL1055B	57
DCL284FZB	68
DCL284FRFB	68
DCL285FZ	68
DCL285FRF	68
DCL286FZW	68
DCL286FRFW	68
VC007GLZ01	75
VC006GMZ01	75
GA5092X01	86
GA5090X01	86
GA5091X01	86
GA5095X01	86
GA5094	86
GA5093X01	86
DLM463Z	102
DLM463PT2	102
DLM465Z	102
DLM465PT2	102
DLM536Z	103
LM001GZ	103
LM002GZ	103
DUH507Z	105
DUH507F001	105
DUH607Z	105
DUH607F001	105
DUH506Z	105
DUH506RF	105
DUH606Z	105
DUH606RF	105
DUB187Z	108
DUB187T001	108
1912R8-4	109
DEAPF400MP	109
UR016GZ	111
UR017GZ	111
UR013GZ04	111
UR014GZ	111
UC100DZ	112
DUC101Z	112
DUC1015F	112
D-75415	114
D-75421	114
E-17049	114
DCU603Z	115
DCU604Z	115
DCU605Z	115
PM001GZ01	116
UP100DSMJ	117

COMBOPACKS

Artikel	Pagina
Combopacks XGT	18-19
Combopacks LXT	51-53
Combopacks CXT	62
Combopacks slijpers	51,88
Combopacks zaagmachines	38,93
Combopacks tuin	118

PROMOTIES

Artikel	Promotie	Pagina
DF001GZ01	B-28606	5
HP001GZ01	B-28606	5
TD001GZ02	E-03567	6
CE001GZ	E-12996	12
LS002GZ01	DEBWST06	17
DK0114G201	BL4025	18
DK0124G201	BL4025	18
DK0125G301	BL4040	18
DK0126G401	BL4040 + DC40RA	19
DK0128G601	191J97-1	19
DHR243Z	BL1830B na online registratie	30
DHR243T1J	BL1830B na online registratie	30
DHR243RTJ	BL1850B	30
DTW700RTJ	DCM501Z	33
DHS680RTJ	BL1850B	38
DLS111ZU	B-67290	39
DLS211ZU	B-67315	39
DTM52RTJX1	LD030P	43
DLX2375T	BL1830B	51
DLX2289T3J	BL1830B	51
DLX2189T3J	BL1830B	51
DLX2440TJ	BL1830B	51
DLX2236TJ1	BL1830B	51
DLX2235T3J	BL1830B	51
DLX2434TJ	BL1830B	51
DLX2194PTJ	BL1830B	51
DLX2245PT1	BL1830B	51
DLX2418TJ	BL1840B	53
DLX4159TJ	BL1840B	53
DLX5070TJ	BL1840B	53
DLX5071TJ	BL1840B	53
DLX6115JX1	2X BL1840B	53
DLX1036TJ1	2X BL1840B	53
DLX1108TJ1	2X BL1840B	53
DCM501Z	BL1830B	56
CLX400SAJ1	UB101DZ	62
DCL182Z	199491-1 + 458571-5	68
DCL280FZ	191D71-3 + 458571-5	68
DCL280FZW	191D71-3 + 458571-5	68
DVC863LZ	CL102DW	74
HR2630TX12	D-42444	77
HR2631FT12	D-42444	77
HR2651TX12	D-42444	77
HR4013C	P-52445	78
HR4511C	P-52445	78
HR5212C	P-52445	78
HM0871C	E-20236	79
HM1812	D-54972	79
LS1019L	DEBWST06	95
LS1219L	DEBWST06	95
SKR200Z	P-81315	99
SK105DZ	BL1021B + DC10SB	100 - 101
SK105GDZ	BL1021B + DC10SB	100 - 101
SK106DZ	BL1021B + DC10SB	100 - 101
SK106GDZ	BL1021B + DC10SB	100 - 101
SK10GDZ	197658-5	100 - 101
SK20GDZ	197658-5	100 - 101
SK40GDZ	197658-5	100 - 101
SK209GDZ	197658-5	100 - 101
SK312GDZ	197658-5	100 - 101
SK700DZ	197658-5	100 - 101
SK700GDZ	197658-5	100 - 101
DUM111SYX	P-84470	106
DUM604RFEX	P-84470	106
DUM604ZX	P-84470	106
UM600DSAEX	P-84470	106
SK20GDZ	UB400MP	109
SK40GDZ	UB400MP	109
SK209GDZ	UB400MP	109
SK312GDZ	E-08458	112
SK700DZ	E-08458	112
SK700GDZ	E-08458	112
DUM111SYX	E-08458	112
DUM604RFEX	E-08458	112
DUM604ZX	E-08458	112
DCU180Z	199009-8 + BL1830B + DC18RC	115



Accu gereedschap

5



Stofzuigers

68



Boor- en breekhamers

77



Boormachines

81



Bevestiging

82



Metaal

83



Slijpers

84



Beton

89



Hout

91



Pneumatisch gereedschap

98



Lasers

99



Tuingereedschap

102

MAKITA WERKT VOLGENS DE RICHTLIJNEN VAN DE EPTA



EPTA staat voor European Power Tool Association en is een vereniging van de belangrijkste fabrikanten van power tools. De EPTA stelt verplichte richtlijnen op, waardoor uniforme en vergelijkbare specificaties en gegevens gegarandeerd worden. Zo zijn er richtlijnen voor het gewicht (zonder snoer maar met alle machine toebehoren die voor het normale gebruik noodzakelijk zijn), voor slagkracht, enz.

In het verleden had iedere fabrikant zijn eigen norm, daarom waren de gegevens voor de invoering van EPTA, van fabrikant tot fabrikant verschillend en niet met elkaar vergelijkbaar.

Om u zo correct mogelijk te informeren, meet Makita uitsluitend volgens de richtlijnen van de EPTA. In al onze media (catalogi, folders, website, enz.) worden daarom enkel waarden conform de EPTA-richtlijnen gebruikt.

XGT

40V *Li-ion* max



Next Generation Technology

XGT is een nieuw platform met specifieke machines, accu's en laders. De combinatie van Makita's bewezen motortechnologie, geavanceerde elektronische sturing en kwalitatieve 40Vmax-batterijen biedt een geweldig alternatief voor de meest veeleisende gebruiker. Het platform vult het bestaande CXT- en LXT-platform aan en is de volgende, logische stap naar een snoerloze toekomst.

Digitale communicatie

Op het XGT-platform kunnen de machines en accu's nu ook onderling digitaal communiceren via geïntegreerde elektronica. Dat resulteert in een perfect energiemangement, optimale prestaties en bovendien een effectieve bescherming van alle componenten bij extreme belasting.

Optimaal laden

Digitaal geoptimaliseerd laadtraject met twee ventilatoren voor een perfecte temperatuurcontrole en continue actieve bijsturing van het laadtraject. Het resultaat zijn nog snellere laadtijden en een langere levensduur van de batterijen.



De nieuwste innovatie in accugereedschap



KRACHTIG



TOEKOMST-GERICHT



INTELLIGENT



BETROUW-BAAR

ACCU (KLOP-)BOOR- EN SCHROEFMACHINES



HP001G / DF001G

- Maximaal koppel tot 140 Nm
- Tot 35 % hogere snelheid
- Bestand tegen continu werken onder hoge belasting

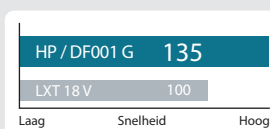

Tot 35 % hogere rotatiesnelheid en meer koppel
Maakt het mogelijk om meer werk te verrichten op kortere tijd.



41 elektronische koppelinstellingen
Voor een groter instelbereik en grotere nauwkeurigheid.

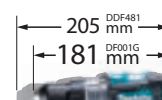

Uiterst compact
In vergelijking met de LXT-variant 24 mm korter.



Active Feedback sensing Technology
Schakelt de machine uit bij een plots zwenkbeweging.



DF001GZ01 & HP001GZ01:
gratis 37-delige schroefbitset B-28606

	DF001GZ01	DF001GM201	DF002GZ01	DF002GD201	HP001GZ01	HP001GM201	HP002GZ01	HP002GD201
Spanning	36 V (40Vmax)	36 V (40Vmax)	36 V (40Vmax)	36 V (40Vmax)	36 V (40Vmax)	36 V (40Vmax)	36 V (40Vmax)	36 V (40Vmax)
Bijgeleverde accu's	0	2 x BL4040	0	2 x BL4025	0	2 x BL4040	0	2 x BL4025
Lader	-	DC40RA	-	DC40RA	-	DC40RA	-	DC40RA
Max. koppel zacht / hard	68 / 140 Nm	68 / 140 Nm	30 / 64 Nm	30 / 64 Nm	68 / 140 Nm	68 / 140 Nm	30 / 64 Nm	30 / 64 Nm
Boorkop	1,5 - 13 mm	1,5 - 13 mm	1,5 - 13 mm	1,5 - 13 mm	1,5 - 13 mm	1,5 - 13 mm	1,5 - 13 mm	1,5 - 13 mm
Klopboorfunctie	-	-	-	-	✓	✓	✓	✓
Gewicht	2,7 kg	2,7 kg	2,5 kg	2,5 kg	2,7 kg	2,7 kg	2,6 kg	2,6 kg
Prijs in €	excl. btw							
	incl. btw							

Ezychange T.C.T. gatzagen

- ✓ Ezychange snelwisselsysteem: één adapter voor alle diameters!
- ✓ Drie zijdelingse gaten zorgen voor een efficiënte verwijdering van zaagafval.
- ✓ Wolframcarbide tanden (T.C.T.): extreem hard, lange levensduur, hoge snijnsnelheid!

ARTIKEL	DIAMETERS (MM)	Nuttige lengte (mm)	Prijs excl. Btw	Prijs incl btw
E-14261	22, 25, 32, 44, 51, 68	60		



Ezychange
TCT

Ezychange
TCT

Ezychange BIM gatzagen

- ✓ Ezychange snelwisselsysteem: één adapter voor alle diameters
- ✓ Variabele vertanding voor snelle zaagsnedes
- ✓ HSS-bimetaal met 8% kobalt voor een hoge duurzaamheid

Artikel	Diameter (mm)	Nuttige lengte (mm)	Prijs excl. btw	Prijs incl btw
E-12310	16, 20, 25, 32, 40, 51	44		
E-12304	19, 22, 29, 38, 44, 57	44		
E-12326	20, 25, 32, 40, 51, 65	44		
E-12295	25, 32, 40, 51, 65, 68, 76	44		



Ezychange
Bi-Metal HSS 8%Co

ACCU SLAGSCHROEVENDRAAIERS



TD003G

- Hoog koppel en geschikt voor continu zwaar gebruik
- Minder extra functies dan TD001G maar uitstekende prijs/kwaliteitsverhouding
- Eenvoudige keuze van het slagenergie: 4 modi en één T-modus (voor het schroeven van zelftappende schroeven in dun metaal)
- "Lichtmodus" (gebruik als zaklamp)

TD001GD201



Promo: gratis 11-delige schroefbitset IMPACT PREMIER bij TD001G



Tot 15% sneller schroeven

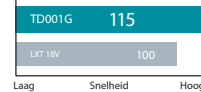

TD003GZ01



NIEUW

	TD003GZ01	TD001GZ02	TD001GD201	TD001GM201
Spanning	36 V (40Vmax)	36 V (40Vmax)	36 V (40Vmax)	36 V (40Vmax)
Bijgeleverde accu's	-	-	2 x BL4025	2 x BL4040
Lader	-	-	DC40RA	DC40RA
Bitopname	1/4 " hex	1/4 " hex	1/4 " hex	1/4 " hex
Max. koppel	210 Nm	220 Nm	220 Nm	220 Nm
Slagkrachtniveaus	4	4	4	4
Hulpfuncties	1	6	6	6
Gewicht	1,7-2,9 kg	1,7-2,9 kg	1,7-2,9 kg	1,7-2,9 kg
Prijs in €	excl. btw			
	incl. btw			

NEXT GENERATION TECHNOLOGY

ACCU HAAKSE BOORMACHINE

BL
MOTOR

XGT
40V Li-ion
max



DA001GM101

- Zeer hoog koppel (136 Nm)
- Twee mechanische snelheden
- Ingebouwde mechanische slipkoppeling

	DA001GZ01	DA001GM101
Spanning	36 V (40Vmax)	36 V (40Vmax)
Bijgeleverde accu's	-	1 x BL4040
Bijgeleverde lader	-	DC40RA
Toerental	0 - 400 t.p.m. 0 - 1500 t.p.m.	0 - 400 t.p.m. 0 - 1500 t.p.m.
Hard koppel	70/136 Nm	70/136 Nm
Boorkop	13 mm	13 mm
Gewicht	5,3 - 6,2 kg	5,3 - 6,2 kg
Prijs in €	excl. btw	
	incl. btw	

ACCU COMBIHAMERS SDS-PLUS

BL
MOTOR

AWS
Auto-start Wireless System

XGT
40V Li-ion
max



	HR007GZ01	HR007GM201	HR002GZ02	HR002GZ05	HR002GM202	HR002GM204	HR009GZ02	HR009GM202
Spanning	36 V (40Vmax)	36 V (40Vmax)	36 V (40Vmax)	36 V (40Vmax)	36 V (40Vmax)	36 V (40Vmax)	36 V (40Vmax)	36 V (40Vmax)
Bijgeleverde accu's	-	2 x BL4040	-	-	2 x BL4040	2 x BL4040	-	2 x BL4040
Lader	-	DC40RA	-	-	DC40RA	DC40RA	-	DC40RA
Slagenergie	3,0 J	3,0 J	2,9 J	2,9 J	2,9 J	2,9 J	3,9 J	3,9 J
Max. Ø beton	28 mm	28 mm	28 mm	28 mm	28 mm	28 mm	30 mm	30 mm
Trillingsniveau (ah)	7,5 m/s ²	7,5 m/s ²	6,0 m/s ²	6,0 m/s ²	6,0 m/s ²	6,0 m/s ²	9,1 m/s ²	9,1 m/s ²
Stofafzuigingsunit	DX15: optioneel	DX15: optioneel	DX14: optioneel	DX14: inbegrepen	DX14: optioneel	DX14: inbegrepen	DX11: inbegrepen	DX11: inbegrepen
AWS	✓ (excl. Bluetooth unit)	✓ (excl. Bluetooth unit)	✓	✓	✓	✓	✓ (excl. Bluetooth unit)	✓ (excl. Bluetooth unit)
Gewicht	5,0 kg	5,0 kg	4,1 kg	5,7 kg	4,1 kg	5,7 kg	5,2 - 6,8 kg	5,2 - 6,8 kg
Prijs in €	excl. btw							
	incl. btw							

AFT Active feedback sensing technology

Deze technologie schakelt de motor onmiddellijk uit bij het plots blokkeren van de machine. De HR002G, HR007G en HR009G maken daarbij gebruik van een accelerometer die de zwenkbeweging van de machine detecteert. De AFT-technologie verhoogt de veiligheid enorm.



HR005G

- Uitstekende vermogen/gewichtsverhouding
- Beveiliging tegen terugslag (AFT met accelerometer)
- Actieve trillingsdemping (AVT)

Slagenergie
8,0 J



HR005GM202

HR006G

- 2 x 40Vmax accu's in serie zorgen voor extreme kracht
- Beveiliging tegen terugslag (AFT met accelerometer)
- Actieve trillingsdemping (AVT)



Slagenergie
20,0 J

HR006GZ



	HR005GZ01	HR005GM202	HR006GZ
Spanning	36 V (40 Vmax)	36 V (40 Vmax)	2 x 36 V (40 Vmax)
Bijgeleverde Accu's	-	2 x BL4040	-
Slagenergie	8,0 J	8,0 J	20,0 J
Slagfrequentie	1450 - 2900 min ⁻¹	1450 - 2900 min ⁻¹	1100 - 2250 min ⁻¹
Trillingsniveau (ah)	5 m/s ²	5 m/s ²	8,5 m/s ²
Capaciteit beton	40 mm	40 mm	52 mm
Toerental onbelast	250 - 500 min ⁻¹	250 - 500 min ⁻¹	250 - 310 min ⁻¹
AWS	✓	✓	✓ (excl. Bluetooth unit)
Gewicht	7,4 kg - 8,2 kg	7,4 kg - 8,2 kg	12,9 - 14,3 kg
Prijs in €	excl. btw		
	incl. btw		

NEXT GENERATION TECHNOLOGY

ACCU BREEKHAMERS SDS-MAX

BL
MOTOR

XGT
40V LITHIUM
max

XGT X2
80Vmax

HM001G



Slagenergie
9,4 J

- Evenaart de kracht van modellen op netstroom
- Hoge slagenergie (9,4 J)
- Uitzonderlijk laag trillingsniveau dankzij actieve trillingsdemping (AVT) en een anti-vibratie behuizing



HM001GM205

Slagenergie
9,4 J



HM002GZ03

Slagenergie
20,0 J

HM002G



- Extreem krachtig dankzij twee 40Vmax accu's in serie
- Zeer hoge slagenergie (20 J)
- Uitzonderlijk laag trillingsniveau dankzij actieve trillingsdemping (AVT) en een anti-vibratie behuizing

	HM001GZ04	HM001GM205	HM002GZ03
Spanning	36 V (40Vmax)	36 V (40Vmax)	2 x 36 V (40Vmax)
Bijgeleverde accu's	-	2 x BL4040	-
Bijgeleverde lader	-	DC40RA	-
Slagenergie	9,4 J	9,4 J	20 J
Slagfrequentie	0 - 2650 min ⁻¹	0 - 2650 min ⁻¹	950 - 1900 min ⁻¹
Triax. vibratie beitelten (ah)	6,0 m/s ²	6,0 m/s ²	8,0 m/s ²
AWS	✓	✓	✓ excl. Bluetoothunit
Gewicht	6,3 - 7,1 kg	6,3 - 7,1 kg	12,0 - 13,3 kg
Prijs in €	excl. btw		
	incl. btw		

ACCU MINIBRADPISTOOL 18 GA



FN001GZ02

	FN001GZ02	FN001GA202
Spanning	36 V (40Vmax)	36 V (40Vmax)
Bijgeleverde accu's	-	2x BL4020
Bijgeleverde lader	-	DC40RA
Lengte nagels	15 - 40 mm	15 - 40 mm
Capaciteit magazijn	100	100
Makpac	✓	✓
Gewicht	2.6 - 3.2 kg	2.6 - 3.2 kg
Prijs in €	excl. btw	
	incl. btw	

ACCU AFWERKINGSPISTOOL 23 GA



PT001GZ01

- Werkt sneller dankzij BL motor en herontworpen indrijvingsveer
- Mechanisme met bewegend tegengewicht voor lage terugslag

	PT001GZ01	PT001GD101
Spanning	36 V (40Vmax)	36 V (40Vmax)
Bijgeleverde accu's	-	1x BL4025
Bijgeleverde lader	-	DC40RA
Lengte nagels	15 - 35 mm	15 - 35 mm
Capaciteit magazijn	120	120
Makpac	✓	✓
Gewicht	2.4 - 3.0 kg	2.4 - 3.0 kg
Prijs in €	excl. btw	
	incl. btw	

ACCU SLAGMOERSLEUTELS



TW001G



TW004GD201



TW007GZ01



Robuust slagmechanisme

BL-motor



Uiterst compact



217 mm



3 hulpfuncties voor het automatisch stoppen van de rotatie, zowel bij het vastdraaien als het losdraaien.

HULPFUNCTIES VOOR HET VASTDRAAIEN EN LOSDRAAIEN VAN BOUTEN

	Rechtsom (vastdraaien)	Linksom (losdraaien)
Boutfunctie	Deze functie helpt om continu schroeven erin te draaien met hetzelfde aandraaimoment. Deze functie helpt ook de kans te verkleinen dat de bouten/moeren breken als gevolg van te strak vastdraaien.	Deze functie helpt voorkomen dat een bout eraf valt. Bij het losdraaien van een bout, zal het gereedschap automatisch stoppen of langzamer gaan draaien zodra de bout/moer voldoende los zit.
mode 1	Het gereedschap stopt automatisch zodra de slagwerking is begonnen.	Het gereedschap stopt automatisch zodra de slagwerking is gestopt.
mode 2	Het gereedschap stopt automatisch ongeveer 0,5 seconde na het moment waarop de slagwerking is begonnen.	Het gereedschap stopt automatisch ongeveer 0,2 seconde na het moment waarop de slagwerking is gestopt.
mode 3	Het gereedschap stopt automatisch ongeveer 1 seconde na het moment waarop de slagwerking is begonnen.	Het gereedschap gaat langzamer draaien nadat de slagwerking is gestopt.

TW004GZ TW004GD201 TW007GZ01 TW007GD201 TW001GZ01

	TW004GZ	TW004GD201	TW007GZ01	TW007GD201	TW001GZ01
Spanning	36 V (40Vmax)	36 V (40Vmax)	36 V (40Vmax)	36 V (40Vmax)	36 V (40Vmax)
Bijgeleverde accu's	0	2 x BL4025	0	2x BL4025	0
Bijgeleverde lader	-	DC40RA	-	DC40RA	-
Toerental	0-3200 tpm	0-3200 tpm	600-2300 tpm	600-2300 tpm	0-1800 tpm
Max. koppel	350 Nm	350 Nm	760 Nm	760 Nm	1800 Nm
Dopaansluiting	1/2"	1/2"	1/2"	1/2"	3/4"
Verpakking	-	Makpac	Makpac	Makpac	Makpac
Gewicht	2,2 kg	2,2 kg	2,7 - 3,3 kg	2,7 - 3,3 kg	3,9 kg
Prijs in €	excl. btw				
	incl. btw				

NEXT GENERATION TECHNOLOGY

ACCU HAAKSE SLIJERS 125 MM

BL
MOTOR

AWS
Auto-start Wireless System

XGT
40V Li-ion
max

Tot 40 % sneller doorslijpen

GA005G 140

LXT 18 V 100

Laag snijsnelheid hoog

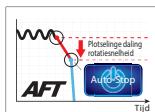

Active Feedback sensing Technology
Schakelt de motor uit bij het plots blokkeren van de schijf

Duurzaam

- De BL-motor is verankerd met een zwaar uitgevoerde kogellager.
- Nieuw ontworpen schakelaar die zeer goed bestand is tegen slijtage.

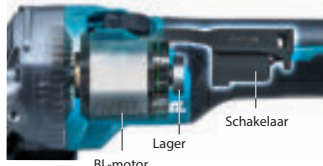

STOFAFZUIGING VOOR SLIJERS



191F81-2



191G06-2

Gereedschapsloze beschermkap

- Er is geen gereedschap nodig om de kap te monteren of te verwijderen.
- De beschermkap kan via een kliksysteem in de gewenste stand geplaatst worden.

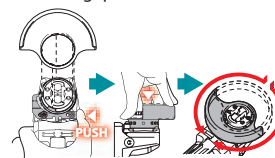

GA023GM201

	GA013GZ01	GA013GM201	GA005GZ01	GA005GM201	GA023GZ	GA023GM201	GA029GZ	GA029GM201
Spanning	36 V (40Vmax)	36 V (40Vmax)	36 V (40Vmax)	36 V (40Vmax)	36 V (40Vmax)	36 V (40Vmax)	36 V (40Vmax)	36 V (40Vmax)
Bijgeleverde accu's	0	2 x BL4040	0	2 x BL4040	0	2 x BL4040	0	2 x BL4040
Bijgeleverde lader	-	DC40RA	-	DC40RA	-	DC40RA	-	DC40RA
Toerental onbelast	8500 t.p.m.	8500 t.p.m.	8500 t.p.m.	8500 t.p.m.	3000 - 8500 t.p.m.	3000 - 8500 t.p.m.	3000 - 8500 t.p.m.	3000 - 8500 t.p.m.
Regelbaar toerental	-	-	-	-	✓	✓	✓	✓
Type schakelaar	Lepelschakelaar	Lepelschakelaar	Schuifschakelaar	Schuifschakelaar	Schuifschakelaar	Schuifschakelaar	Lepelschakelaar	Lepelschakelaar
Dodemansschakelaar	✓	✓	-	-	-	-	✓	✓
AWS	-	-	-	-	✓	✓	✓	✓
Verpakking	Makpac	Makpac	Makpac	Makpac	-	Makpac	-	Makpac
Gewicht	3,0 kg	3,0 kg	3,0 kg	3,0 kg	3,0 kg	3,0 kg	3,0 kg	3,0 kg
Prijs in €	excl. btw							
	incl. btw							

ACCU HAAKSE SLIJERS 125 MM X-LOCK

BL
MOTOR

AWS
Auto-start Wireless System

XGT
40V Li-ion
max

XLOCK

Snel en veilig schijven bevestigen via een kliksysteem.



GA044GM201



191G05-4
STOFAFZUIGKAP X-LOCK

	GA041GZ	GA041GM201	GA044GZ	GA044GM201	GA047GZ	GA047GM201
Spanning	36 V (40Vmax)	36 V (40Vmax)	36 V (40Vmax)	36 V (40Vmax)	36 V (40Vmax)	36 V (40Vmax)
Bijgeleverde accu's	-	2x BL4040	-	2x BL4040	-	2x BL4040
Bijgeleverde lader	-	DC40RA	-	DC40RA	-	DC40RA
Schijfdiameter	125 mm	125 mm	125 mm	125 mm	125 mm	125 mm
Toerental onbelast	3,000 - 8,500 min ⁻¹	3,000 - 8,500 min ⁻¹	3,000 - 8,500 min ⁻¹	3,000 - 8,500 min ⁻¹	8,500 min ⁻¹	8,500 min ⁻¹
Slijpdiepte	31 mm	31 mm	31 mm	31 mm	31 mm	31 mm
Type schakelaar	Schuifschakelaar	Schuifschakelaar	Lepelschakelaar	Lepelschakelaar	Lepelschakelaar	Lepelschakelaar
Dodemansschakelaar	-	-	✓	✓	✓	✓
AWS	✓	✓	✓	✓	-	-
Verpakking	-	Makpac	-	Makpac	-	Makpac
Gewicht	3,0 - 5,3 kg	3,0 - 5,3 kg	3,0 - 5,3 kg	3,0 - 5,3 kg	3,0 - 5,3 kg	3,0 - 5,3 kg
Prijs in €	excl. btw					
	incl. btw					

ACCU DOORSLIJPER 355 MM

BL
MOTOR

XGT X2
80V_{max}



- Uiterst krachtig dankzij 2x 40Vmax technologie
- Met soft start, AFT en elektrische rem
- Geïntegreerde watertoevoer
- XPT en Wetguard (IPX4) bescherming
- De combinatie van AVT technologie en een trillingsabsorberende behuizing zorgen voor een zeer laag vibratieniveau.

Promo: gratis
diamantschijf
355 mm E-12996

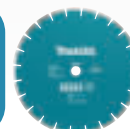

CE001GZ

Spanning	72 V (80Vmax)
Bijgeleverde accu's/lader	-
Ø zaagblad	355 mm
Toerental onbelast	5300 min ⁻¹
Max. zaagdiepte	127 mm
Trillingsniveau (ah) vooraan / achteraan	2,5 m/s ² / 1,8 m/s ²
Gewicht	12,3 - 14,1 kg
Prijs in €	excl. btw
	incl. btw

ACCU METAALCIRKELZAAG 185 MM

BL
MOTOR

XGT
40V_{max} L^{Li-ion}



CS002GZ

- Grote snijcapaciteit dankzij de compacte tandwieloverbrenging
- Compartiment in aluminium voor het opvangen van metaalsnippers
- De AFT functie schakelt de motor onmiddellijk uit wanneer het zaagblad blokkeert

CS002GZ

Spanning	36 V (40Vmax)
Bijgeleverde accu's/lader	-
Ø zaagblad	185 mm
Toerental onbelast	3500 min ⁻¹
Max. zaagdiepte	67 mm
Trillingsniveau (ah)	2,5 m/s ²
Gewicht	4,2 - 5,4 kg
Prijs in €	excl. btw
	incl. btw

ACCU HAAKSE SLIPPERS 150 MM / 180 MM / 230 MM

BL
MOTOR

AWS
Auto-start Wireless System

XGT
40V_{max} L^{Li-ion}



Compacte afmetingen en kleine omtrek van de handgreep



GA038GM201



	GA035GZ	GA036GZ	GA037GZ01	GA037GM201	GA037GT201	GA038GZ01	GA038GM201	GA038GT201
Spanning	36 V (40Vmax)	36 V (40Vmax)	36 V (40Vmax)	36 V (40Vmax)	36 V (40Vmax)	36 V (40Vmax)	36 V (40Vmax)	36 V (40Vmax)
Bijgeleverde accu's	-	-	-	2 x BL4040	2 x BL4050F	-	2 x BL4040	2 x BL4050F
Bijgeleverde lader	-	-	-	DC40RA	DC40RA	-	DC40RA	DC40RA
Schijfdiameter	150 mm	150 mm	180 mm	180 mm	180 mm	230 mm	230 mm	230 mm
Toerental onbelast	8500 min ⁻¹	8500 min ⁻¹	7800 min ⁻¹	7800 min ⁻¹	7800 min ⁻¹	6600 min ⁻¹	6600 min ⁻¹	6600 min ⁻¹
Slijpdiepte	46 mm	46 mm	68 mm	68 mm	68 mm	73 mm	73 mm	73 mm
Type schakelaar	Schuifschakelaar	Lepelschakelaar	Lepelschakelaar	Lepelschakelaar	Lepelschakelaar	Lepelschakelaar	Lepelschakelaar	Lepelschakelaar
Dodemansschakelaar	-	-✓	✓	✓	✓	✓	✓	✓
AWS	-	-	excl. Bluetooth unit	excl. Bluetooth unit	excl. Bluetooth unit	excl. Bluetooth unit	excl. Bluetooth unit	excl. Bluetooth unit
Verpakking	-	-	Koffer	Koffer	Koffer	Koffer	Koffer	Koffer
Gewicht	3,0 - 3,7 kg	3,0 - 3,7 kg	4,4 - 5,4 kg	4,4 - 5,4 kg	4,4 - 5,4 kg	4,6 - 7,4 kg	4,6 - 7,4 kg	4,6 - 7,4 kg
Prijs in €	excl. btw							
	incl. btw							

NEXT GENERATION TECHNOLOGY

ACCU MENGER



- Zeer krachtig, ook geschikt voor het mengen van zwaardere materialen
- Mechanische overbrenging met 2 snelheden
- Duimwielje voor het instellen van het maximaal toerental, variabel toerental regeling, aan-vergrendelknop en uit-vergrendelknop, softstart
- Inschroefbare ashouder met adapter M12 + M14 binnendraad
- Uitstekende bescherming van schakelaar en accu

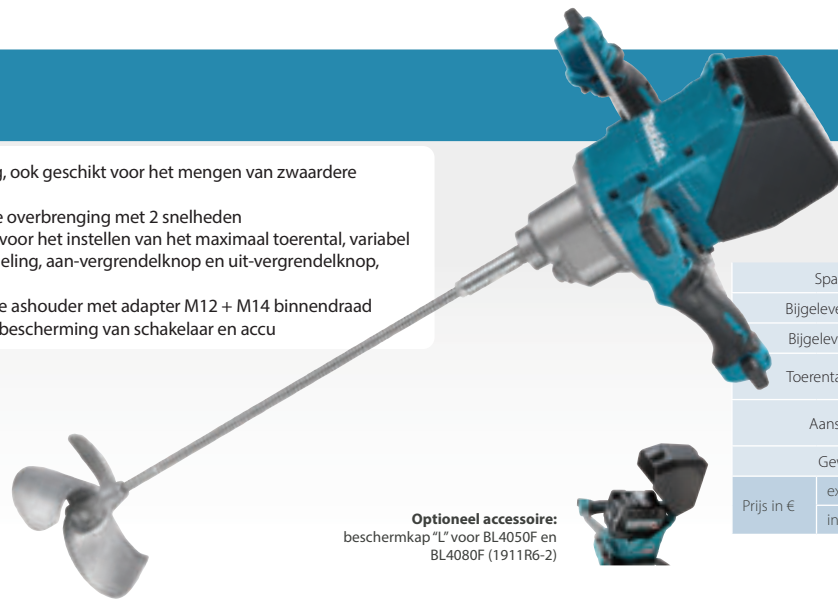

Optioneel accessoire:
beschermkap "L" voor BL4050F en BL4080F (1911R6-2)

NIEUW

UT001GZ02

Spanning	36V (40Vmax)
Bijgeleverde accu's	-
Bijgeleverde lader	-
Toerental onbelast	0- 500min ⁻¹ 0- 920min ⁻¹
Aansluiting	1/2" - 20 UNF Male Adapter M12 & M14
Gewicht	5,7-7,0 kg
Prijs in €	excl. btw
	incl. btw

ACCU BETONTRILNAALDEN



VR001GZ



VR003GZ



ACCESSOIRES

Artikel	Diameter	Lengte	Prijs excl. btw	Prijs incl. btw
1910E1-5	32 mm	1,2 m		
1910E2-3	32 mm	1,7 m		
1910C2-9	32 mm	2,4 m		
1910E3-1	38 mm	1,2 m		
1910C4-5	38 mm	2,4 m		

	VR001GZ	VR003GZ	VR003GM101	VR004GZ	VR004GM101
Spanning	36 v (40Vmax)	36 v (40Vmax)	36 v (40Vmax)	36 v (40Vmax)	36 v (40Vmax)
Bijgeleverde accu's	-	-	1x BL4040	-	1x BL4040
Bijgeleverde lader	-	-	DC40RA	-	DC40RA
Ø triffles	-(enkel motor)	32 mm	32 mm	38 mm	38 mm
Lengte naald	-(enkel motor)	1,2 m	1,2 m	1,2 m	1,2 m
Trillingsfrequentie	12000-15000 min ⁻¹	12000-15000 min ⁻¹	12000-15000 min ⁻¹	12000-15000 min ⁻¹	12000-15000 min ⁻¹
Gewicht	4,8 - 7,8 kg	4,8 - 7,8 kg	4,8 - 7,8 kg	4,8 - 7,8 kg	4,8 - 7,8 kg
Prijs in €	excl. btw				
	incl. btw				



JR002GM201



JR002G



JR001GD201



Gedempte ophanging

De accu en de behuizing zijn verbonden met trillingsabsorberende rubbers.

- Vermogen vergelijkbaar met model op netstroom
- Met pendelmechanisme (JR002G)
- Zeer laag trillingsniveau dankzij AVT technologie
- Handige bladontgrendelingshendel en verstelbare aanslag
- Ledverlichting

Gereedschapsloze aanpassing van de aanslag

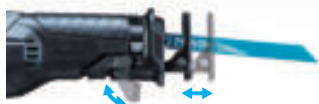

	JR001GZ	JR001GD201	JR001GM201	JR002GZ	JR002GM201
Spanning	36 V (40Vmax)	36 V (40Vmax)	36 V (40Vmax)	36 V (40Vmax)	36 V (40Vmax)
Bijgeleverde accu's	0	2 x BL4025	2 x BL4040	-	2 x BL4040
Bijgeleverde lader	-	DC40RA	DC40RA	-	DC40RA
Slaglengte	32 mm	32 mm	32 mm	32 mm	32 mm
Aantal zaagbewegingen	0 - 2300 min ⁻¹ 0 - 3000 min ⁻¹	0 - 2300 min ⁻¹ 0 - 3000 min ⁻¹	0 - 2300 min ⁻¹ 0 - 3000 min ⁻¹	0 - 3000 min ⁻¹ 0 - 3000 min ⁻¹	0 - 3000 min ⁻¹ 0 - 3000 min ⁻¹
Pendelinstelling	-	-	-	✓	✓
AVT	-	-	-	✓	✓
Gewicht	4,2 kg	4,2 kg	4,2 kg	4,6 kg	4,6 kg
Prijs in €	excl. btw				
	incl. btw				



PB002GM201

- Grote zaagcapaciteit tot Ø127 mm
- Variabele snelheidsregeling
- Hoge bandsnelheid
- Gemakkelijke spoorverstelling

	PB002GZ	PB002GM201
Spanning	36 V (40Vmax)	36 V (40Vmax)
Bijgeleverde accu's	-	2x BL4040
Bijgeleverde lader	-	DC40RA
Zaagcapaciteit	127 x 127 mm	127 x 127 mm
Zaaglint	1140 x 13 x 0,5 mm	1140 x 13 x 0,5 mm
Gewicht	6,6 - 7,8 kg	6,6 - 7,8 kg
Prijs in €	excl. btw	
	incl. btw	



PV001GM101



	PV001GZ	PV001GM101
Spanning	36 V (40Vmax)	36 V (40Vmax)
Bijgeleverde accu's	-	1x BL4040
Bijgeleverde lader	-	DC40RA
Diameter	180 mm	180 mm
Toerental onbelast	0 - 2200 min ⁻¹	0 - 2200 min ⁻¹
Gewicht	3,2 - 3,9 kg	3,2 - 3,9 kg
Prijs in €	excl. btw	
	incl. btw	

NEXT GENERATION TECHNOLOGY

ACCU BOVEN- EN KANTENFREES



- Compact en flexibel systeem
- Zeer hoog vermogen dankzij 40Vmax technologie
- Zachte rem
- Verschillende hulpstukken meegeleverd

RT001GM208

	RT001GZ16	RT001GM208
Spanning	36 V (40Vmax)	36 V (40Vmax)
Toerental onbelast	10000-31000 min ⁻¹	10000-31000 min ⁻¹
Max. induikdiepte	40 mm	40 mm
Ø spantang - bereik	6 - 8 mm	6 - 8 mm
Ø spantang - inbegrepen	6 mm, 8 mm	6 mm, 8 mm
AWS	✓	✓
Bijgeleverde accu's	-	2x BL4040
Bijgeleverde lader	-	DC40RA
Gewicht	2,2 - 2,5 kg	2,2 - 2,5 kg
Prijs in €	excl. btw	
	incl. btw	

ACCU SCHAAF



- Even krachtig als een machine op netstroom
- Kan tot 4,0 mm in één passage schaven
- Spaanders kunnen links of rechts uitgeworpen worden
- Zool met 3 groeven voor het afschuiven van kanten
- Sponningsdiepte tot 25 mm

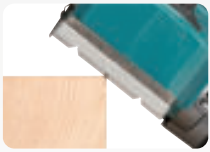

KP001GM202

	KP001GZ01	KP001GM202
Spanning	36 V (40Vmax)	36 V (40Vmax)
Toerental onbelast	15000 min ⁻¹	15000 min ⁻¹
Schaafbreedte	82 mm	82 mm
Max. spaanafname	40mm	40mm
AWS	✓	✓
Bijgeleverde accu's	-	2x BL4040
Bijgeleverde lader	-	DC40RA
Gewicht	3,7 - 4,9 kg	3,7 - 4,9 kg
Prijs in €	excl. btw	
	incl. btw	

ACCU INVALCIRKELZAAG



SP001GZ03

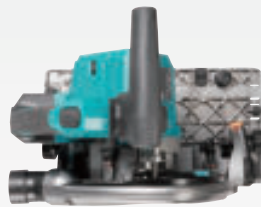

Compact en licht, perfect uitgebalanceerd.
Door het gebruik van slechts één 40Vmax accu en magnesium componenten.



Perfekte geleiding
De magnesium zool past rechtstreeks op een geleiderail.



Grote zaagcapaciteit
Zaagdiepte van 56 mm bij 90° en een kantelbereik van -1 tot 48°.



AWS compatibel
Voor het draadloos aansturen van een AWS compatibele stofzuiger. (incl. Bluetooth unit)

	SP001GZ03
Spanning	36 V (40Vmax)
Ø zaagblad	165 mm
Toerental onbelast	2500 - 4900 min ⁻¹
Zaagdiepte (90°)	56 mm
AWS	✓
Bijgeleverde accu's	0
Gewicht	4,4 - 5,0 kg
Prijs in €	excl. btw
	incl. btw

HS012G

- Bijzonder krachtige accucirkelzaag met links geplaatst zaagblad.
- Compact, licht en perfect uitgebalanceerd dankzij de nieuw ontwikkelde BL motor.
- Diepteregeling met duidelijk afleesbare schaal en kantelbaar tot 45°.
- De zool en beschermkap zijn uitgevoerd in hoogwaardig magnesium.
- Opgelet deze machine past niet rechtstreeks op een geleiderail.



NIEUW

	HS012GZ01	HS003GZ	HS003GM201	HS004GZ	HS004GZ01	HS004GM202	HS009GZ	HS009GT201	HS010GZ	HS010GT201	HS011GZ	HS011GT201
Spanning	36 V (40Vmax)	36 V (40Vmax)	36 V (40Vmax)	36 V (40Vmax)	36 V (40Vmax)	36 V (40Vmax)	36 V (40Vmax)	36 V (40Vmax)	36 V (40Vmax)	36 V (40Vmax)	36 V (40Vmax)	36 V (40Vmax)
Bijgeleverde accu's	-	-	2 x BL4040	-	-	2 x BL4040	-	2x BL4050F	-	2x BL4050F	-	2x BL4050F
Bijgeleverde lader	-	-	DC40RA	-	-	DC40RA	-	DC40RA	-	DC40RA	-	DC40RA
Ø zaagblad	165 mm	190 mm	190 mm	190 mm	190 mm	190 mm	235 mm	235 mm	235 mm	235 mm	270 mm	270 mm
Zaagdiepte (90°)	57 mm	68,5 mm	68,5 mm	62,5 mm	62,5 mm	62,5 mm	85 mm	85 mm	85 mm	85 mm	101 mm	101 mm
Rechtstreeks op geleiderail	-	-	-	✓	✓	✓	✓	✓	-	-	✓	✓
AWS	✓ excl. Bluetooth unit	✓ excl. Bluetooth unit	✓ excl. Bluetooth unit	✓ excl. Bluetooth unit	✓	✓	✓ excl. Bluetooth unit	✓ excl. Bluetooth unit	✓ excl. Bluetooth unit	✓ excl. Bluetooth unit	✓ excl. Bluetooth unit	✓ excl. Bluetooth unit
Verpakking	Makpac	-	Makpac	-	-	Makpac	-	Koffer	-	Koffer	-	-
Gewicht	3,2 - 4,4kg	4,1 - 4,4 kg	4,1 - 4,4 kg	4,4 - 4,7 kg	4,4 - 4,7 kg	4,4 - 4,7 kg	5,1 - 5,7 kg	5,1 - 5,7 kg	6,0 - 6,4 kg	6,0 - 6,4 kg	5,5 - 6,7 kg	5,5 - 6,7 kg
Prijs in €	excl. btw											
	incl. btw											

NEXT GENERATION TECHNOLOGY

ACCU CIRKELZAGEN MET ACHTERHANDGREEP



RS001GM101



RS002GT101



- Speciaal ontwerp met handgreep achteraan
- Krachtig en licht (magnesium zool)



	RS001GZ	RS001GM101	RS002GZ	RS002GT101
Spanning	36 V (40Vmax)	36 V (40Vmax)	36 V (40Vmax)	36 V (40Vmax)
Bijgeleverde accu's	0	1 x BL4040	0	1 x BL4050F
Zaagdiepte (90°)	65 mm	65 mm	95 mm	95 mm
Ø zaagblad	185 mm	185 mm	260 mm	260 mm
AWS	-	-	excl Bluetooth unit	excl Bluetooth unit
Toerental onbelast	6400 min ⁻¹	6400 min ⁻¹	4000 min ⁻¹	4000 min ⁻¹
Gewicht	5,0 - 5,6 kg	5,0 - 5,6 kg	5,7 - 6,3 kg	5,7 - 6,3 kg
Prijs in €	excl. btw			
	incl. btw			

ACCU TELESCOPISCHE AFKORT - VERSTEKZAGEN



Belangrijke bedieningsknoppen zijn vooraan geplaatst

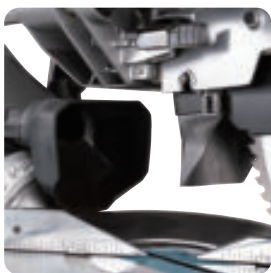

Effectieve stofafzuiging

De geoptimaliseerde stofafzuiging met twee poorten garandeert een perfecte stofafzuiging, ook bij het zagen van dunne planken.



LS002GZ01

Promo:
gratis onderstel
DEBWS06
t.w.v.



Uitschuifbare zijsteunen

Kantelhoek 48°
links en rechts

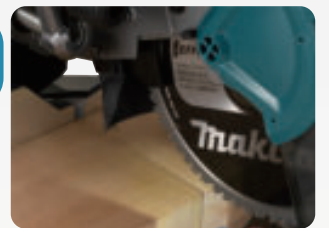

Aanduiding van de zaaglijn

Een LED werpt een schaduw van het zaagblad op het werkstuk, deze aanduiding is onder alle omstandigheden exact.



LS003GZ01

	LS002GZ01	LS004GZ01	LS003GZ01
Spanning	36 V (40Vmax)	36 V (40Vmax)	36 V (40Vmax)
Bijgeleverde accu's	0	0	0
Ø zaagblad	216 mm	260 mm	305 mm
Verstekhoek	60 L / 60 R	60° L / 60° R	60 L / 60 R
Kantelhoek	48° L / 48° R	48° L / 48° R	48° L / 48° R
Toerental onbelast	4800 min ⁻¹	3600 min ⁻¹	3600 min ⁻¹
Capaciteit	70 x 312 mm	91 x 312 mm	107 x 312 mm
AWS	✓	✓	✓
DXT	✓	✓	✓
Gewicht	16,4 - 17,0 kg	26,6 - 27,2 kg	30,5 - 31,1 kg
Prijs in €	excl. btw		
	incl. btw		

DXT

Deep and Exact Cutting Technology

De gepatenteerde constructie met drieduidige tandwieloverbrenging en uitsparing achter de flens laat toe om een groter deel van het zaagblad te benutten. Daardoor kunnen ook hoge plinten verticaal of in verstek afgekort worden.



Manuele bediening

De afzuiging kan via een schakelaar ook manueel gestart worden (via Bluetooth), dit is ook handig om de machine schoon te maken.

COMBOPACK XGT

XGT
40V^{Li-ion}
max



Promo: gratis
extra accu 2,5 Ah

DK0114G201

Bijgeleverde accu's	2 x BL4040
Lader	DC40RA
Laadadapter	ADP10
Klopboor- en schroef- machine	HP001G
Slagschroevendraaier	TD001G
Verpakking	Gereedschapstas
Prijs in €	excl. btw incl. btw

COMBOPACK XGT

XGT
40V^{Li-ion}
max



Promo: gratis
extra accu 2,5 Ah

DK0124G201

Bijgeleverde accu's	2 x BL4040
Lader	DC40RA
Boor- en schroefmachine	DF001G
Haakse slijper 125 mm	GA005G
Verpakking	Makpac
Prijs in €	excl. btw incl. btw

COMBOPACK XGT

XGT
40V^{Li-ion}
max



Promo: gratis
extra accu 4,0 Ah

DK0125G301

Bijgeleverde accu's	2 x BL4040
Lader	DC40RA
Boor- en schroefmachine	DF001G
Slagschroevendraaier	TD001G
Haakse slijper 125 mm	GA005G
Verpakking	Makpac
Prijs in €	excl. btw incl. btw

NEXT GENERATION TECHNOLOGY

COMBOPACK XGT

XGT
40V Li-ion
max

Promo: gratis extra
accu 4,0 Ah + extra
lader DC40RA



DK0126G401

Haakse slijper 125 mm	GA005G
Reciprozaag	JR001G
Boor- en schroefmachine	DF001G
Bijgeleverde accu's	2 x BL4040
Lader	DC40RA
Slagschroevendraaier	TD001G
Verpakking	Gereedschapstas
Prijs in €	excl. btw
	incl. btw

COMBOPACK XGT

XGT
40V Li-ion
max



Promo: gratis
Powerpack 4,0 Ah
t.w.v.

DK0128G601

Bijgeleverde accu's	2 x BL4040
Lader	DC40RA
Boor- en schroefmachine	DF001G
Slagschroevendraaier	TD001G
Haakse slijper 125 mm	GA005G
Reciprozaag	JR001G
SDS plus combihamer	HR002G
Cirkelzaag 190 mm	HS003G
Verpakking	Gereedschapstas
Prijs in €	excl. btw
	incl. btw



1. CHOOSE YOUR BODY!

2. CHOOSE YOUR POWER!

3. MIX IT UP!



191L29-0 Li-ion accu BL4020 40Vmax • 2,0 Ah • 0,69 kg • 22 min*	191B36-3 Li-ion accu BL4025 40Vmax • 2,5 Ah • 0,71 kg • 28 min*	191B26-6 Li-ion accu BL4040 40Vmax • 4,0 Ah • 1 kg • 45 min*	191L47-8 Li-ion accu BL4050F 40Vmax • 5,0 Ah • 1,3 kg • 50 min*	191X65-8 Li-ion accu BL4080F 40Vmax • 8,0 Ah • 2,0 kg • 80 min*
--	--	---	--	--



191J81-6 XGT Powerpack 2,5 Ah	191J65-4 XGT Powerpack 4,0 Ah	191J97-1 XGT Powerpack 4,0 Ah	191V35-5 XGT Powerpack 5,0 Ah	191U00-8 XGT Powerpack 4,0 Ah
---	---	---	---	---



191U28-6 XGT Powerpack 4,0 Ah	191U13-9 XGT Powerpack 5,0 Ah	191U42-2 XGT Powerpack 5,0 Ah	191Y97-1 XGT Powerpack 8,0 Ah
---	---	---	---



* Laadtijd met DC40RA

191E07-8
Oplader DC40RA
Snellader voor XGT 40Vmax accu's



191N09-8
Duo snellader DC40RB
Duo snellader voor het gelijktijdig laden van twee XGT 40Vmax accu's



191C10-7
ADP10 Laadadapter
Adapter om LXT 14,4 V en 18 V accu's te laden op een XGT 40Vmax lader



DEAADP001G
ADP001 Laadadapter
USB-adapter voor XGT 40Vmax accu's



1910D9-2
Communicatie adapter ADP12
Adapter om XGT-producten te verbinden met smartphone, laptop,...

* de adapter wordt enkel tussen machine en accu geplaatst tijdens controle / bij het maken van de gewenste instellingen



NIEUW

- Diefstalbeveiliging instellen d.m.v. een pincode
- De werkingsduur van accu's instellen
- De gebruikshistoriek van de XGT-machines raadplegen

COMPRESSOR



NIEUW

AC001GZ

- Compact en lichtgewicht ontwerp, ideaal voor binnentoeepassingen zoals nieten en spijkeren
- Olivrijze pomp met hoog luchtdebiet
- Manometer voor zowel tank- als uitgangsdruk
- Laag geluidsniveau
- Stevig metalen frame beschermt de motor en compressor en vergemakkelijkt het transport



Spanning	36V (40Vmax)
Bijgeleverde accu's	-
Debiet	34 l/min @ 6,0 bar
Inschakeldruk	7,2 bar
Uitschakeldruk	9,4 bar
Uitgangsdruk	0 - 9,3 bar
Geluidsdrukkniveau	68 dB(A)
Gewicht	10,1 - 12,8 kg
Prijs in €	excl. btw
	incl. btw

LUCHTPOMP



MP001GZ

- Door het hoge debiet kunnen grotere banden en bijvoorbeeld ook speelgoed voor op het water opgeblazen worden.
- Drie modi: hoog debiet, laag debiet en "ball" mode om op een veilige manier speelballen op te blazen.
- Functie voor het aflaten van lucht indien de druk te hoog is.

Spanning	36 V (40Vmax)
Bijgeleverde accu's	0
Debiet	12 - 24 l/min
Max. druk	11,1 bar
Gewicht	2,9 - 3,5 kg
Prijs in €	excl. btw
	incl. btw

BLAAS- EN ZUIGMACHINE



- 4 vermogenstanden en variabele snelheid
- Handig kliksysteem voor het verwisselen van mondstukken
- Kan ook lucht wegzuigen via een optioneel accessoire
- Standaard geleverd met 5 blaasmonden



Toepassingen:

- Schoonblazen (gereedschap, machines, computers).
- Reinigen van luchtfilters
- Uitblazen van ankerkragen
- Opblazen/aflaten van strandballen, bootjes enz.
- Leegzuigen van verpakkingen (compacteer maken)



• Standaard



• Optioneel



AS001GZ

Spanning	36 V (40Vmax)
Bijgeleverde accu's)	-
Bijgeleverde lader	-
Blaaskracht	2,8 N
Debiet	0 - 1,3 m ³ /min
Max. onderdruk	103 mbar
Gewicht	1,5 - 2,3 kg
Prijs in €	excl. btw
	incl. btw

ACCU VENTILATOREN



AC adapter inbegrepen



CF001GZ



CF002GZ

- Voeding via accu of netroom
- Met zwenkfunctie en timer
- Hoge luchtsnelheid en stille werking
- Afneembare bescherming voor gemakkelijk reinigen



	CF001GZ	CF002GZ
Spanning	36 V (40Vmax) XGT / AC (Incl. AC-adapter)	36 V (40Vmax) XGT / AC (Incl. AC-adapter)
Diameter	235 mm	330 mm
Debiet (stand 1-2-3)	5,2 / 6,5 / 8,2 m ³ /min	10 / 15 / 21 m ³ /min
Luchtsnelheid	120 / 150 / 190 m/min	120 / 170 / 240 m/min
Gewicht	2,0 - 3,0 kg	4,5 - 5,1 kg
Prijs in €	excl. btw	
	incl. btw	

MICROGOLFOVEN



- Ideaal om voeding op te warmen op plaatsen waar geen netstroom beschikbaar is.
- Werkt met één 40Vmax accu of twee in parallel.
- Zeer compacte afmetingen, gemakkelijk te transporteren.
- Twee vermogenniveaus: 350W en 500W
- De verwarmingstijd kan ingesteld worden van 10 seconden tot 20 minuten.
- Met 2x BL4040 en op volle vermogen kunnen ongeveer 5 maaltijden of 8 koppen van 200 ml opgewarmd worden.



NIEUW

MW001GZ

Spanning	36V (40Vmax)
Inhoud	8 l
Bijgeleverde accu's	-
Bijgeleverde lader	-
Binnenafmetingen	255 x 241 x 120 mm
Uitgangsvermogen	350 W / 500 W
Autonomie (2x BL4040)	350 W: 21 min 500 W: 15 min
Gewicht	9,5 - 12,7 kg
Prijs in €	excl. btw
	incl. btw

Leverbaar ten vroegste vanaf mei 2023

WATERKOKER



- Voeding met één XGT accu of twee in parallel
- Dubbellaagse roestvrijstalen wand
- Met voedingsstandaard en groot handvat
- Uitgerust met morsbeveiliging

KT001GZ

Spanning	36 V (40Vmax)
Inhoud	0,8 l
Kooktijd voor 0,8 l	ca. 8 min
Verwarmcapaciteit 100 °C	1,2 l met 2 x BL4025
Gewicht	2,8 - 5,9 kg
Prijs in €	excl. btw
	incl. btw

VRIES-/ KOELBOX MET VERWARMFUNCTIE



CW003GZ

CW001GZ

CW002GZ01

- Voeding via accu's of netstroom
- Hoog koelvermogen dankzij compressor
- 7 temperatuurinstellingen voor koelen en 7 voor verwarmen
- Uitgebreid statusdisplay



NIEUW

	CW003GZ	CW001GZ	CW002GZ01
Voeding	36 V (40Vmax) XGT / 18 V LXT / AC / 12 V DC - 24 V DC	36 V (40Vmax) XGT / 18 V LXT / AC / 12 V DC - 24 V DC	36 V (40Vmax) XGT / 18 V LXT / AC / 12 V DC - 24 V DC
Inhoud	7 l	20 l	50 l
Koelen	-18 / -15 / -10 / -5 / 0 / 5 / 10 °C	-18 / -15 / -10 / -5 / 0 / 5 / 10 °C	-18 / -15 / -10 / -5 / 0 / 5 / 10 °C
Verwarmen	30 / 35 / 40 / 45 / 50 / 55 / 60 °C	30 / 35 / 40 / 45 / 50 / 55 / 60 °C	30 / 35 / 40 / 45 / 50 / 55 / 60 °C
Autonomie ca.	-18 °C: 5,5 uur, 5 °C: 13,5 uur, 60 °C: 5,5 uur (1x BL4040)	-18 °C: 8 uur, 5 °C: 22,5 uur, 60 °C: 7 uur (2x BL4040)	-18 °C: 8 uur, 5 °C: 19,5 uur, 60 °C: 4,5 uur (2x BL4040)
Afmetingen	456 x 245 x 308 mm	663 x 341 x 372 mm	867 x 465 x 476 mm
Gewicht	7,9 - 9,4 kg	13,8 - 17,3 kg	25,6 - 29,0 kg
Prijs in €	excl. btw		
	incl. btw		

Het grootste 18 V Lithium-ion assortiment ter wereld.

Meer dan 380 machines met slechts één accu.

18V
LITHIUM-ION

3
JAAR
GARANTIE
OP MACHINES
Na registratie op
www.makita.be

LXT

Lithium-Ion Extreme Technology

- + Performante Lithium-Ion accu's
- + Een unieke en snelle oplaadtechnologie
- + Energie-efficiënte koolborstelloze motoren
- + Meervoudige bescherming tegen overbelasting





Invalcirkelzaag

Kettingzaag

Doorslijper

Cirkelzagen

Haakse slijpers

Invalzagen

Haakse boormachines

2x 18V

18V

Hoogsnoeier

Grastrimmer

Snoeischaar

Bladblazers

Stofzuigers

Waterkoker

Ruggedragen stofzuigers

Combisysteem

Staande stofzuiger

Grasmaaiers

Haagschaar

Hogedrukreiniger

Vacuumpomp

Slagmoersleutels

Boormachine

Menger

Slagschroevendraaiers

Schroefmachines

Schroefautomaten

Haakse slag-schroevendraaiers

Slagschroevendraaiers

Ratelmoersleutel

Haakse boormachines

Klopboormachines

Boren- en
slijpmachine

Bijhamer

Boorhamers

Combihamers
SDS-plus

Multitool

Betonijzerzaag

Plaatschaar

Knabberschaar

Schuurpolijst-
machine

Draadstangknippers

Zaagmachines

Bandzagen

Gipszaag

Boven- en
kantenfrees

Reciprozagen

Langnek-
schuurmachine

Handpalm-
schuurmachines

Polijstmachines

Metaalcirkelzagen

Bandschuurmachine

Cirkelzagen

Langnek-
schuurmachine

Handpalm-
schuurmachines

Polijstmachines

Lamellenfrees

Decoupeerzagen

Langnek-
schuurmachine

Handpalm-
schuurmachines

Polijstmachines

Lamellenfrees

Decoupeerzagen

Langnek-
schuurmachine

Handpalm-
schuurmachines

Polijstmachines

18V
LITHIUM-ION

LXT-Platform

Betrouwbaar – veelzijdig – krachtig

Snel en optimaal laden

Wanneer de batterijen warm zijn, dan is het belangrijk dat die eerst gekoeld worden vooraleer het laadtraject te starten. De lader is uitgerust met een ventilator die de batterijen koelt vóór en tijdens het laden om de laadtijd te verkorten.

Makita geavanceerd laadsysteem
Geforceerde koeling



Standaard laadsysteem
Natuurlijke warmteafvoer



Digitale communicatie

De processor communiceert met de in de batterij ingebouwde chip om te laden bij de optimale spanning, stroom en temperatuur en om de levensduur van de batterij te optimaliseren.



Geoptimaliseerd laadtraject

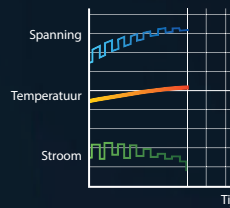

Standaard laadtraject

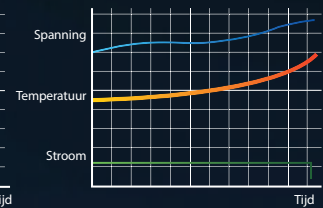

3.0Ah
Li-ion

22 minuten

3,0 Ah
BL1830B

SNELSTE LAADTIJD

4.0Ah
Li-ion

36 minuten

4,0 Ah
BL1840B

5.0Ah
Li-ion

45 minuten

5,0 Ah
BL1850B

6.0Ah
Li-ion

55 minuten

6,0 Ah
BL1860B

LANGSTE WERKDUUR



DRAAGBAAR ACCUPACK

PDC01

PDC1200

191A59-5

PDC01 ZONDER BATTERIJEN

Inclusief adapter
18 V & 2 x 18 V



191C50-5

PDC01 MET 4 x BL1850B EN
DUOSNELLADER DC18RD

PDC01 KAN TOT 4 LXT-
BATTERIJEN DRAGEN



BL1850B

DC18RD

BEAPDC1200A01

DRAAGBAAR ACCUPACK PDC1200
MET GEÏNTEGREERDE BATTERIJCELLEN

ENERGIECAPACITEIT
1206 Wh



Inclusief lader 191L00-4
(DC4001) en adapter
191J51-5 (2 x 18 V)

197280-8

accu BL1850B 18V 5,0 Ah



197288-2

TWINPACK 18V 2 x 5,0 Ah



197422-4

accu BL1860B 18V 6,0 Ah



DECADP05

USB-adapter

USB-adapter voor 14,4V/18V accu's



197494-9

POWERPACK 18V 2 x 4,0 Ah



197624-2

POWERPACK 18V 2 x 5,0 Ah



197629-2

POWERPACK 18V 2 x 5,0 Ah



197626-8

POWERPACK 18V 4 x 5,0 Ah



198116-4

Powerpack 18V 2 x 6,0 Ah



198077-8

POWERPACK 18V 2 x 6,0 Ah



198091-4

POWERPACK 18V 4 x 6,0 Ah



198170-8

accu timer LXT BPS01
Programmeert de werkdur van
14,4V & 18V accu's



195584-2

OPLADER DC18RC

Snellader voor LXT accu's van 14,4/18V



196933-6

DUBBELLADER DC18RD

Duo snellader voor LXT accu's: 14,4/18V



2 accu's BL1850 laden
in 45 minuten

198720-9

OPLADER DC18RE

Snellader voor zowel CXT als LXT accu's



LXT

CXT

196426-3

Oplader DC18SF

Oplader met 4 poorten voor LXT accu's.
Laadt twee accu's tegelijk op



(traaglader)

ACCU BOOR- EN SCHROEFMACHINE

14.4V
LITHIUM-ION



incl. 59 accessoires

DDF343RYX2

DDF343RYX2

Spanning	14,4 V
Bijgeleverde accu's	2 x BL1415N
Hard koppel	36 Nm
Boorkop	1-10 mm
Gewicht	1,4 kg
Prijs in €	excl. btw
	incl. btw

ACCU (KLOP-)BOOR- EN SCHROEFMACHINE

18V
LITHIUM-ION



DHP453RFX2

incl. 96 accessoires

DHP453RFX2

Spanning	18 V
Bijgeleverde accu's	2 x BL1830B
Hard koppel	42 Nm
Boorkop	1,5-13 mm
Gewicht	1,7 kg
Prijs in €	excl. btw
	incl. btw

ACCU (KLOP-)BOOR- EN SCHROEFMACHINES

MAK PAC

18V
LITHIUM-ION



DDF485RTJ3



DDF484RTJ3



DDF486RTJ3

DDF453RF3J DDF482RT3J DDF485RT3J DDF484RT3J DDF486RT3J DHP486RT3J

Spanning	18 V	18 V	18 V	18 V	18 V	18 V
Bijgeleverde accu's	3 x BL1830B	3 x BL1850B	3 x BL1850B	3 x BL1850B	3 x BL1850B	3 x BL1850B
BL-motor	-	-	✓	✓	✓	✓
Klopboorfunctie	-	-	-	-	-	✓
Hard koppel	42 Nm	62 Nm	50 Nm	54 Nm	130 Nm	130 Nm
Boorkop	1,5-13 mm	1,5-13 mm	1,5-13 mm	1,5-13 mm	1,5 - 13 mm	1,5 - 13 mm
Gewicht	1,7 kg	1,7 kg	1,5 kg	1,5 kg	2,3 - 2,6 kg	2,3 - 2,7 kg
Prijs in €	excl. btw					
	incl. btw					

PROMO

3e Accu

ACCU (KLOP-)BOOR- EN SCHROEFMACHINES



	DDF083ZJ	DDF487RAJ	DDF485RTJ	DDF484RTJ	DDF486RTJ	DHP487RAJ	DHP485RFJ	DHP484RTJ	DHP486RTJ
Spanning	18V	18V	18V	18V	18V	18V	18V	18V	18V
Bijgeleverde accu's	-	2 x BL1820	2 x BL1850B	2 x BL1850B	2 x BL1850B	2 x BL1820	2 x BL1830B	2 x BL1850B	2 x BL1850B
Klopboorfunctie	-	-	-	-	-	✓	✓	✓	✓
Hard koppel	40 Nm	40 Nm	50 Nm	54 Nm	130 Nm	40 Nm	50 Nm	54 Nm	130 Nm
Opname	1/4 hex	1,5 - 13 mm	1,5-13 mm	1,5-13 mm	1,5-13 mm	1,5 - 13 mm	1,5-13 mm	1,5-13 mm	1,5 - 13 mm
Gewicht	1,1 - 1,4 kg	1,3 - 1,6 kg	1,4 kg	1,5 kg	1,3 kg	1,3 - 1,6 kg	1,4 kg	1,6 kg	2,3 - 2,7 kg
Prijs in €	excl. btw								
	incl. btw								

ACCU HAAKSE BOORMACHINES



	DDA350RTJ	DDA351RTJ	DDA450RTE	DDA460ZK
Spanning	18V	18V	18V	2 x 18V
Bijgeleverde accu's	2 x BL1850B	2 x BL1850B	2 x BL1850B	-
Toerental	0-1800 t.p.m.	0-1800 t.p.m.	0 - 450 t.p.m. 0 - 1400 t.p.m.	0-350 t.p.m. 0-1400 t.p.m.
BL motor	-	-	✓	✓
XPT	-	-	✓	✓
Hard koppel	13,7 Nm	13,7 Nm	26/70 Nm	70/136 Nm
Boorkop	1,5-10 mm	1,5-10 mm	1,5-13 mm	1,5-13 mm
Gewicht	1,8 kg	1,8 kg	3,2 kg	5,7 kg
Prijs in €	excl. btw			
	incl. btw			

ACCU BIKHAMER SDS-PLUS



DHK180RTJ



		DHK180ZJ	DHK180RTJ
Spanning		18V	18V
Bijgeleverde accu's		0	2 x BL1850B
Slagenergie		3,1 J	3,1 J
Slagfrequentie		0 - 3200/min	0 - 3200/min
Triaxiale vibratiewaarde (ah)		4,5 m/s ²	4,5 m/s ²
Gewicht		3,3 kg	3,3 kg
Prijs in €	excl. btw		
	incl. btw		

ACCU BOORHAMERS SDS-PLUS



DHR171RTJ



PROMO

Gratis 3e BL1850B bij DHR243RTJ



DHR202RTJ



DHR182RTWJ



DHR243RTJ



DHR183RTWJ

- DHR183RTWJ**
- Verhoogde slagenergie dankzij nieuwe motor
 - AVT, trillingsdempende constructie en trillingsdempende zijhandgreep
 - Inclusief nieuwe stofafzuigingsmodule DX16 (1911P2-6)

**DHR182RTWJ
DHR243RTJW
DHR183RTWJ
incl. STOF AFZUIGING**



NIEUW

		DHR171RTJ	DHR183RTWJ	DHR202RTJ	DHR182RTJ	DHR182RTWJ	DHR243RTJ	DHR243RTJW
Spanning		18V	18V	18V	18V	18V	18V	18V
Bijgeleverde accu's		2 x BL1850B	2 x BL1850B	2 x BL1850B	2 x BL1850B	2 x BL1850B	2 x BL1850B	2 x BL1850B
Slagenergie		1,2 J	1,7 J	2 J	1,7 J	1,7 J	2 J	2 J
Max. Ø beton		16 mm	16 mm	20 mm	18 mm	18 mm	24 mm	24 mm
BL-motor		✓	✓	-	✓	✓	✓	✓
AVT		-	✓	-	✓	✓	-	-
AWS		-	-	-	✓ excl. Bluetooth unit	✓ excl. Bluetooth unit	-	-
Stofafzuigingsysteem		-	DX16	-	-	DX05	-	DX07
Gewicht		2,1 kg	2,1 - 2,8 kg	3,5 kg	2,4 kg	3,3 kg	3,2 kg	4,7 kg
Prijs in €	excl. btw							
	incl. btw							

Wist je dat er van DHR243 ook de voordelige uitvoeringen DHR243Z en DHR243T1J bestaan? Zie p. 52-53 voor meer info!

PROMO

Gratis BL1830B na online registraties bij DHR243Z / DHR243T1J



Technologie

AFT

Active feedback sensing technology

Deze technologie schakelt de motor onmiddellijk uit bij het plots blokkeren van de machine. Sommige machines zoals de DHR283 maken daarbij gebruik van een accelerometer die de zwenkbeweging van de machine detecteert. De AFT-technologie verhoogt de veiligheid enorm.

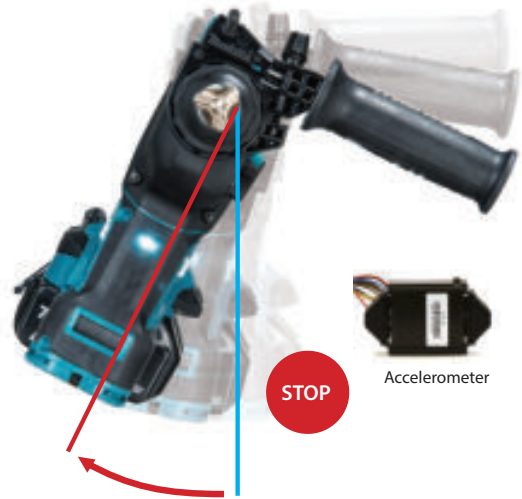
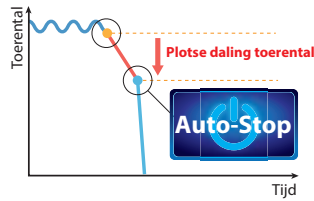

AVT

Anti-vibration technology

Het AVT-systeem reduceert trillingen drastisch door het gebruik van een systeem met bewegend tegengewicht, hetgeen het gebruikscomfort sterk verbetert.

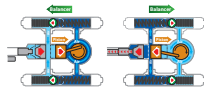

Auto-start wireless system

Dankzij AWS wordt de stofafzuiging bij accu-toestellen automatisch geactiveerd d.m.v. een Bluetooth®-verbinding.



ACCU COMBIHAMERS SDS-PLUS



DHR283G2JU



DHR264PT2J

AWS
AVT
AFT

DHR283ZWJU
inclusief
STOFAFZUIGING



Alle modellen
INCLUSIEF extra
automatische
boorkop



	DHR264PT2J	DHR283ZJU	DHR283ZWJU	DHR283G2JU
Spanning	2 x 18V	2 x 18V	2x18V	2 x 18V
Bijgeleverde accu's	2 x BL1850B	0	0	2 x BL1860B
BL-motor	-	✓	✓	✓
Slagenergie	2,5 J	2,8 J	2,8 J	2,8 J
Max. Ø beton	26 mm	28 mm	28 mm	28 mm
AWS	-	✓	✓	✓
AVT	-	✓	✓	✓
AFT	-	✓	✓	✓
Stofafzuigstelsysteem	-	-	DX09	-
Gewicht	4,2 kg	4,0 kg	5,5 kg	4,0 kg
Prijs in €	excl. btw			
	incl. btw			

PREMIUM BEITELSET SDS-PLUS EN SDS-MAX

- ✓ 2 keer langere levensduur dan de standaard beitels!
- ✓ Zeer efficiënt: vormvast. Het afbraakwerk is veel productiever!

3-DELIGE PREMIUM BEITELSET SDS-PLUS

SDS- PLUS

E-04911

excl. btw

incl. btw



1 puntbeitel 250 mm
1 koudbeitel 20 x 250 mm
1 platte beitel 40 x 250 mm



AntiJam™ ontwerp

Verhoogt de productiviteit
Vermindert de wrijving en de kans op blokkeren
Speciaal ontworpen voor SDS-PLUS machines

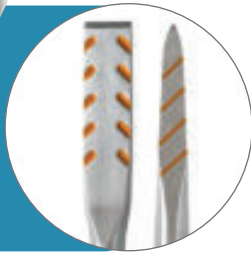

5-DELIGE PREMIUM BEITELSET SDS-MAX

SDS- MAX

E-20236

excl. btw

incl. btw

NIEUW



2 puntbeitels 400 mm
2 koudbeitels 25 x 400 mm
1 platte beitel 80 mm



BreakPower™ ontwerp

Verhoogt de productiviteit
Vermindert de wrijving en de kans op blokkeren
Speciaal ontworpen voor SDS-MAX machines

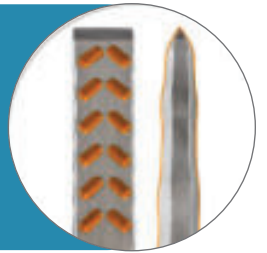

ACCU COMBIHAMER SDS-MAX

BL MOTOR AVT

AWS 18V + 18V → 36V



DHR400ZKU1
incl. stofafzuiging 199142-6

DHR400ZKU DHR400ZKUN DHR400ZKU1 DHR400G2UN

Spanning	2 x 18V	2 x 18V	2 x 18V	2 x 18V
Bijgeleverde accu's	-	-	-	2 x BL1860B
Slagenergie	8 J	8 J	8 J	8 J
Max. Ø beton	40 mm	40 mm	40 mm	40 mm
Vibratieniveau hamerboren	5,0 m/s ²	5,0 m/s ²	5,0 m/s ²	5,0 m/s ²
AWS	✓	✓	✓	✓
AFT	-	✓	-	✓
Gewicht	8,1 kg	8,1 kg	8,1 kg	8,1 kg
Prijs in €	excl. btw			
	incl. btw			

ACCU HETELUCHTPISTOLEN

MAX 21C 18V LITHIUM-ION



DHG180RT1J



DHG181RT1J

- Snelle wissel van het mondstuk
- Veilige schakelaar, te blokkeren in uit en aan stand
- Verschillende mondstukken zijn inbegrepen

	DHG180RT1J	DHG181RT1J
Spanning	18V	18V
Bijgeleverde accu's	1x BL1850B	1x BL1850B
Temperatuurbereik	550 °C	6 standen, max 550 °C
Debiet	200 l/min	120 l/min, 200 l/min
Gewicht	1,0 - 1,3 kg	1,0 - 1,4 kg
Prijs in €	excl. btw	
	incl. btw	

ACCU SLAGMOERSLEUTELS



Auto-stop:
de machine stopt automatisch van zodra de bout of moer voldoende is losgedraaid

PROMO

Gratis koffiezet-apparaat DCM501Z bij DTW700RTJ

Wist je dat er van DTW300 de voordelige uitvoeringen DTW300Z en DTW300TJ bestaan? Zie p. 52-53 voor meer uitleg!



DTW1001RTJ



DTW190RTJ



DTW300RTJ



DTW700RTJ



DTW181RTJ

	DTW181RTJ	DTW190RTJ	DTW300RTJ	DTW700RTJ	DTW1001RTJ	DTW1002RTJ
Spanning	18V	18V	18V	18V	18V	18V
Bijgeleverde accu's	2 x BL1850B	2 x BL1850B	2 x BL1850B	2 x BL1850B	2 x BL1850B	2 x BL1850B
BL-motor	✓	-	✓	✓	✓	✓
XPT	✓	-	✓	✓	-	-
Toerental	0-2400 tpm.	0-2400 tpm.	0-3200 tpm.	0-2200 tpm.	0-1800 t.p.m.	0-1800 t.p.m.
Max. koppel	180 Nm	190 Nm	330 Nm	700 Nm	1050 Nm	1000 Nm
Dopaansluiting	1/2" vierkant	1/2" vierkant	1/2" vierkant	1/2" vierkant	3/4" vierkant	1/2" vierkant
Auto-stop functie	✓	-	✓	✓	-	-
Gewicht	1,2 kg	1,4 kg	1,8 kg	2,6 kg	3,4 kg	3,3 kg
Prijs in €	excl. btw					
	incl. btw					

ACCU RATELMOERSLEUTEL



Geleverd met 1/4" & 3/8" opname

Verwijderbare kop laat toe om 13 mm moeren over de lengte van een M8 draadstang te schroeven.



DWR180ZJ

	DWR180ZJ	DWR180RA1J
Spanning	18V	18V
Bijgeleverde accu's	0	1 x BL1820B
Toerental onbelast	0-800 t.p.m.	0-800 t.p.m.
Max. koppel	47,5 Nm	47,5 Nm
Gewicht	1,2 kg	1,2 kg
Prijs in €	excl. btw	
	incl. btw	

ACCU BREEKMOERSLEUTEL



- Voor het vastdraaien van torsiebreekbouten met een hoge trekvastheid (type HRC/tor-shear).
- Torsiebreekbouten worden vooral gebruikt bij industriële staalconstructies.

	DWT310ZK
Spanning	2x18V
Bijgeleverde accu's	-
Toerental onbelast	14 min ⁻¹
Max. koppel	804 Nm
Gewicht	6,5 - 7,1 kg
Prijs in €	excl. btw
	incl. btw



Impact PREMIER

ACCESSOIRES

IMPACT PREMIER

Duurzamer door de dubbele torsie!



E-13568
5-delige schroefbitset



Past zeer nauwkeurig in de schroef.

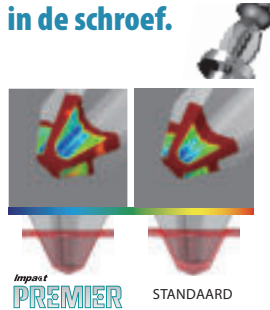

E-03567
11-delige schroefbitset



Gebruik van hoogwaardig staal. Ondersteunt een hoog koppel.

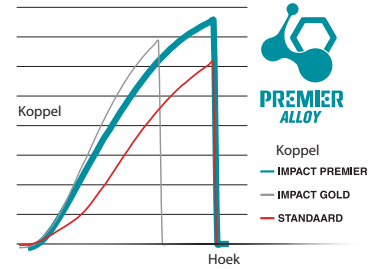

E-13552
31-delige schroefbitset



- E-03121 Schroefbit IMPACT PREMIER PH1-25 mm, 2 stks
- E-03137 Schroefbit IMPACT PREMIER PH2-25 mm, 2 stks
- E-03143 Schroefbit IMPACT PREMIER PH2(slim)-25 mm, 2 stks
- E-03159 Schroefbit IMPACT PREMIER PH3-25 mm, 2 stks
- E-03165 Schroefbit IMPACT PREMIER PZ1-25 mm, 2 stks
- E-03171 Schroefbit IMPACT PREMIER PZ2-25 mm, 2 stks
- E-03187 Schroefbit IMPACT PREMIER PZ3-25 mm, 2 stks
- E-03193 Schroefbit IMPACT PREMIER T10-25 mm, 2 stks
- E-03202 Schroefbit IMPACT PREMIER T15-25 mm, 2 stks
- E-03218 Schroefbit IMPACT PREMIER T20-25 mm, 2 stks
- E-03224 Schroefbit IMPACT PREMIER T25-25 mm, 2 stks
- E-03230 Schroefbit IMPACT PREMIER T30-25 mm, 2 stks
- E-03246 Schroefbit IMPACT PREMIER PH2-25 mm, 15 stks Flip top
- E-03252 Schroefbit IMPACT PREMIER PZ2-25 mm, 15 stks Flip top



- E-03268 Schroefbit IMPACT PREMIER PH1-50 mm, 2 stks
- E-03274 Schroefbit IMPACT PREMIER PH2-50 mm, 2 stks
- E-03280 Schroefbit IMPACT PREMIER PH3-50 mm, 2 stks
- E-03296 Schroefbit IMPACT PREMIER PZ1-50 mm, 2 stks
- E-03305 Schroefbit IMPACT PREMIER PZ2-50 mm, 2 stks
- E-03311 Schroefbit IMPACT PREMIER PZ3-50 mm, 2 stks
- E-03327 Schroefbit IMPACT PREMIER T10-50 mm, 2 stks
- E-03333 Schroefbit IMPACT PREMIER T15-50 mm, 2 stks
- E-03349 Schroefbit IMPACT PREMIER T20-50 mm, 2 stks
- E-03355 Schroefbit IMPACT PREMIER T25-50 mm, 2 stks
- E-03361 Schroefbit IMPACT PREMIER T30-50 mm, 2 stks
- E-12027 Schroefbit IMPACT PREMIER T40-50 mm, 2 stks
- E-03377 Schroefbit IMPACT PREMIER PH2-50 mm, 10 stks Flip top
- E-03383 Schroefbit IMPACT PREMIER PZ2-50 mm, 10 stks Flip top



- E-06286 Dubbelbit IMPACT PREMIER PH2-65 mm, 2 stks
- E-06292 Dubbelbit IMPACT PREMIER PZ2-65 mm, 2 stks



- E-03399 IMPACT PREMIER Torsion bithouder 68 mm
- E-03408 IMPACT PREMIER Torsion bithouder 150 mm



- E-03414 ULTRA MAG bithouder IMPACT PREMIER TORSION



- E-03420 IMPACT PREMIER Tilt adapter 1/4" voor krachtdoppen 3/8" - 50 mm
- E-03436 IMPACT PREMIER Tilt adapter 1/4" voor krachtdoppen 1/2" - 50 mm



- E-03442 IMPACT PREMIER Mag Boost magneet voor schroefbits



- E-03458 IMPACT PREMIER Torsion dopsleutel H6-65 mm
- E-03464 IMPACT PREMIER Torsion dopsleutel H8-65 mm
- E-03470 IMPACT PREMIER Torsion dopsleutel H10-65 mm
- E-03486 IMPACT PREMIER Torsion dopsleutel H13-65 mm



- E-03492 IMPACT PREMIER krachtdop H13-80 mm
- E-03501 IMPACT PREMIER krachtdop H15-80 mm
- E-03517 IMPACT PREMIER krachtdop H17-80 mm
- E-03523 IMPACT PREMIER krachtdop H19-80 mm
- E-03539 IMPACT PREMIER krachtdop H21-80 mm



- E-03573 11-delige IMPACT PREMIER schroefbitset



ACCU HAAKSE
SLAGSCHROEVENDRAAIER

18V
LITHIUM-ION



MAX
P.T.C.

DTL061RTJ

Spanning	18 V
Bijgeleverde accu's	2 x BL1850B
Toerental	0-2000 t.p.m.
Gewicht	1,8 kg
Prijs in €	excl. btw
	incl. btw

ACCU SLAGSCHROEVENDRAAIERS

XPT

MAX
P.T.C.

18V
LITHIUM-ION

Assist mode: voor het vlot aanzetten bij het schroeven.

T-modus: instelling voor zelftappende schroeven.



DTD157RTJ



DTD153RTJ



DTD172RTJ

Wist je dat er van DTD153 de voordelige uitvoeringen DTD153Z en DTD153T1J bestaan? Zie p. 52-53 voor meer info!

	DTD156RTJ	DTD153RTJ	DTD157RTJ	DTD154RTJ	DTD172RTJ
Spanning	18 V	18 V	18 V	18 V	18 V
Bijgeleverde accu's	2 x BL1850B	2 x BL1850B	2 x BL1850B	2 x BL1850B	2 x BL1850B
BL-motor	-	✓	✓	✓	✓
Toerental	0-2500 t.p.m.	0-3400 t.p.m.	0-3000 t.p.m.	0-3600 t.p.m.	0-3600 t.p.m.
Max. koppel	155 Nm	170 Nm	140 Nm	175 Nm	180 Nm
Bitopname	1/4" hex.	1/4" hex.	1/4" hex.	1/4" hex.	1/4" hex.
Slagkrachtniveaus	-	-	2	3	4
T-modus	-	-	-	✓	✓
Assist mode	-	-	✓	-	✓
Gewicht	1,3 kg	1,5 kg	1,2 kg	1,5 kg	1,5 kg
Prijs in €	excl. btw				
	incl. btw				

ACCU HYBRIDE
BOOR- EN SCHROEFMACHINE

BL
MOTOR

MAX
P.T.C.

18V
LITHIUM-ION



4 modi: klopboren, boren schroeven, slagschroeven

DTP141RTJ

DTP141ZJ DTP141RTJ

Spanning	18 V	18 V
Bijgeleverde accu's	-	2 x BL1850B
Toerental	0-2700 t.p.m.	0-2700 t.p.m.
Gewicht	1,8 kg	1,8 kg
Prijs in €	excl. btw	
	incl. btw	

ACCU HYDRAULISCHE
SLAGSCHROEVENDRAAIER

MAX
P.T.C.

18V
LITHIUM-ION



DTS141ZJ

Uiterst stil dankzij het unieke hydraulische impulsysteem

DTS141ZJ

Spanning	18 V
Bijgeleverde accu's	-
Toerental	0-3200 t.p.m.
Max. koppel	40 Nm
Bitopname	1/4" hex
T-modus	✓
Gewicht	1,5 kg
Prijs in €	excl. btw
	incl. btw

ACCU AFWERKINGSPISTOOL
23 Ga



DPT353RTJ

Spanning	18 V
Bijgeleverde accu's	2 x BL1850B
Doorsnede nagel	0,6 mm
Lengte nagel	15-35 mm
Gewicht	2,0 kg
Prijs in €	excl. btw
	incl. btw

ACCU NIETMACHINES



DST221RTJ

DST221:
Aluminium magazijn

DST112RTJ DST221RTJ

Spanning	18 V	18 V
Bijgeleverde accu's	2 x BL1850B	2 x BL1850B
Rugbreedte niet	10 mm	10,5 mm
Lengte niet	7-10 mm	10-22 mm
Gewicht	1,5 kg	2,1 kg
Prijs in €	excl. btw	
	incl. btw	

ACCU MINIBRADPISTOLEN
18 Ga



DFN350RTJ



DBN500RTJ

DFN350RTJ DBN500RTJ

Spanning	18 V	18 V
Bijgeleverde accu's	2 x BL1850B	2 x BL1850B
Doorsnede nagel	1,2 mm	1,2 mm
XPT	✓	-
Lengte nagel	15-35 mm	15-50 mm
Gewicht	2,1 kg	3,2 kg
Prijs in €	excl. btw	
	incl. btw	

Voor zacht hout

ACCU BRADPISTOOL
16 Ga



Voor zacht hout

DBN600RTJ

Spanning	18 V
Bijgeleverde accu's	2 x BL1850B
Doorsnede nagel	1,6 mm
Lengte nagel	25-64 mm
Gewicht	3,4 kg
Prijs in €	excl. btw
	incl. btw

ACCU LAMELLENFRES



DPJ180RTJ

Spanning	18 V
Bijgeleverde accu's	2 x BL1850B
Toerental	6500 t.p.m.
Gewicht	3,2 kg
Prijs in €	excl. btw
	incl. btw

ACCU SCHAAF



DKP181RTJU



DKP181RTJU

Spanning	18 V
Bijgeleverde accu's	2 x BL1850B
Toerental	12000 t.p.m.
Schaafbreedte	82 mm
Max. spaanafname	3 mm
Sponningdiepte	25 mm
AWS	✓
Gewicht	3,3 kg
Prijs in €	excl. btw
	incl. btw

ACCU RECIPROZAGEN



DJR360PT2

DJR187RTE

DJR188RTJ

DJR189ZJ

DJR189

- Kan met één hand gebruikt worden
- Uitstekend geschikt voor het zagen in nauwe ruimten en in de hoogte
- Uitermate licht en toch zeer krachtig
- Trillingsarm (anti-vibratiesysteem met bewegend tegengewicht)

	DJR189ZJ	DJR183RTJ	DJR186RTE	DJR187RTE	DJR188RTJ	DJR360PT2
Spanning	18V	18V	18V	18V	18V	2 x 18V
Bijgeleverde accu's	-	2 x BL1850B	2 x BL1850B	2 x BL1850B	2 x BL1850B	2 x BL1850B
Bijgeleverde lader	-	DC18RC	DC18RC	DC18RC	DC18RC	DC18RD
BL-motor	✓	-	-	✓	✓	✓
Toerental	0-3100 /min	0-3300 /min	0-2800 /min	0-3000 /min	0-3000 /min	0-3000 /min
Slaglengthe	22 mm	13 mm	32 mm	32 mm	20 mm	32 mm
Max. capaciteit hout	255 mm	50 mm	255 mm	255 mm	255 mm	255 mm
Gewicht	2,2 - 2,5 kg	1,6 kg	3,5 kg	3,4 kg	2,9 kg	4,6 kg
Prijs in €	excl. btw					
	incl. btw					

ACCU DECOUPEERZAGEN



DJV181RTJ

DJV184RTJ

DJV185RTJ

DJV182RTJ

NIEUW

	DJV184RTJ	DJV185RTJ	DJV181RTJ	DJV182RTJ
Spanning	18V	18V	18V	18V
Bijgeleverde accu's	2 x BL1850B	2 x BL1850B	2 x BL1850B	2 x BL1850B
BL motor	✓	✓	✓	✓
Aantal zaagbewegingen	0-3000 min ⁻¹	800-3000 min ⁻¹	800-3500 min ⁻¹	800-3500 min ⁻¹
Max. capaciteit hout	135 mm	135 mm	135 mm	135 mm
Slaglengthe	23 mm	23 mm	26 mm	26 mm
Gewicht	2,1 - 2,4 kg	2,0 - 2,3 kg	2,3 - 2,6 kg	2,4 - 2,7 kg
Prijs in €	excl. btw			
	incl. btw			

Wist je dat er van DJV181 en DJ182 de voordelige uitvoeringen DJV181Z / DJV181T1J en DJV182Z / DJV182T1J bestaan? Zie p. 52-53 voor meer info!

ACCU INVALCIRKELZAGEN
165 mm

18V → 36V

BL MOTOR MAK PAC

Geleiderail
194368-5 bij PT2J1



DSP600PT2J1

DSP601ZJU DSP600PT2J DSP600PT2J1

	DSP601ZJU	DSP600PT2J	DSP600PT2J1
Spanning	2 x 18 V	2 x 18 V	2 x 18 V
Bijgeleverde accu's	0	2 x BL1850B	2 x BL1850B
Zaagdiepte	56 mm	56 mm	56 mm
Diameter asgat	20 mm	20 mm	20 mm
AWS	✓	-	-
Aantal MAKPAC-koffers	1	2	2
Gewicht	4,4 kg	4,4 kg	4,4 kg
Prijs in €	excl. btw		
	incl. btw		

ACCU METAALCIRKELZAGEN

MAK PAC

18V LITHIUM-ION



DCS552RTJ

DCS553RTJ

DCS552RTJ DCS553RTJ

	DCS552RTJ	DCS553RTJ
Spanning	18 V	18 V
Bijgeleverde accu's	2 x BL1850B	2 x BL1850B
BL-motor	-	✓
Ø zaagblad	136 mm	150 mm
Zaagdiepte (90°)	50,5 mm	57,5 mm
Gewicht	2,4 kg	3,0 kg
Prijs in €	excl. btw	
	incl. btw	

COMBOPACK



DSP600

BL1850B

DJV182

DC18RD

DLX2234PX1

Invalcirkelzaag	DSP600
Bijgeleverde accu's	2 x BL1850B
Decoupeerzaag	DJV182
Lader	DC18RD
Prijs in €	excl. btw
	incl. btw

ACCU CIRKELZAGEN

MAK PAC

18V → 36V

18V LITHIUM-ION

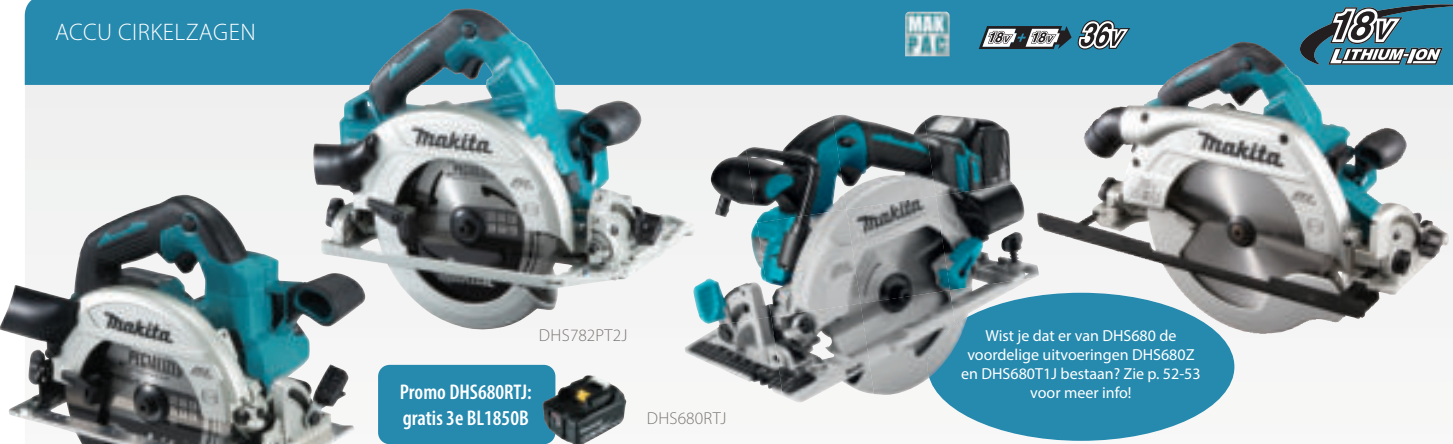

DHS782PT2J

Promo DHS680RTJ:
gratis 3e BL1850B



DHS680RTJ

Wist je dat er van DHS680 de voordelige uitvoeringen DHS680Z en DHS680T1J bestaan? Zie p. 52-53 voor meer info!

DHS660RTJ

DHS782, DHS783 & DHS900
passen rechtstreeks op geleiderail

	DSS501RTJ	DHS680RTJ	DHS660RTJ	DHS661RTJU	DHS630RTJ	DHS710PT2J	DHS782PT2J	DHS783TJU	DHS900PT2	DHS900PT2U
Spanning	18 V	18 V	18 V	18 V	18 V	2 x 18 V	2 x 18 V	2 x 18 V	2 x 18 V	2 x 18 V
Bijgeleverde accu's	2 x BL1850B	2 x BL1850B	2 x BL1850B	2 x BL1850B	2 x BL1850B	2 x BL1850B	2 x BL1850B	2 x BL1850B	2 x BL1850B	2 x BL1850B
BL-motor	✓	✓	✓	✓	-	-	✓	✓	✓	✓
Zaagdiepte (90°)	51 mm	57 mm	57 mm	57 mm	66 mm	68,5 mm	62,5 mm	62,5 mm	85 mm	85 mm
Ø zaagblad	136 mm	165 mm	165 mm	165 mm	165 mm	190 mm	190 mm	190 mm	235 mm	235 mm
AWS	-	-	-	✓	-	-	-	✓	✓	✓
Gewicht	2,7 kg	3,3 kg	3,4 kg	3,4 kg	3,5 kg	4,7 kg	4,5 kg	4,5 kg	5,3 kg	5,3 kg
Prijs in €	excl. btw									
	incl. btw									

excl. Bluetooth unit

ACCU AFKORT-VERSTEKZAAG



DLS600RTE



Spanning	18 V
Bijgeleverde accu's	2 x BL1850B
Ø zaagblad	165 mm
Max. zaagcapaciteit bij 90°	46 x 92 mm
Gewicht	6,6 kg
Prijs in €	excl. btw
	incl. btw

EFFICUT

Fijner, sneller en efficiënter snijden



Scan mij voor meer info!



Meer zaagsneden per batterijlading



Snel zagen



Langere levensduur



Zuivere zaagsnede



ACCU TELESCOPISCHE AFKORT-VERSTEKZAGEN



DXT

Deep and Exact Cutting Technology

De gepatenteerde constructie met drievoudige tandwieloverbrenging en uitsparing achter de flens laat toe om een groter deel van het zaagblad te benutten. Daardoor kunnen ook hoge plinten verticaal of in verstek afgekort worden.

PROMO
DLS111ZU :gratis Efficut zaagblad 80T (B-67290)
DLS211ZU: gratis Efficut zaagblad 80T (B-67315)



DLS714NPT2



DLS211ZU

	DLS714NPT2	DLS111ZU	DLS211ZU
Spanning	2 x 18 V	2 x 18 V	2 x 18 V
Bijgeleverde accu's	2 x BL1850B	promo: B-67290	promo: B-67315
Ø Zaagblad	190 mm	260 mm	305 mm
Zaagdiepte (90°)	52 mm	91 mm	107 mm
Zaagbreedte (90°)	300 mm	310 mm	363 mm
DXT	-	✓	✓
AWS	-	✓	✓
Gewicht	13,0 kg	27,3 kg	30,7 kg
Prijs in €	excl. btw		
	incl. btw		



ACCU MENGER



Ideaal voor het mengen van vloeistoffen, verf en lichte lijmsorten.

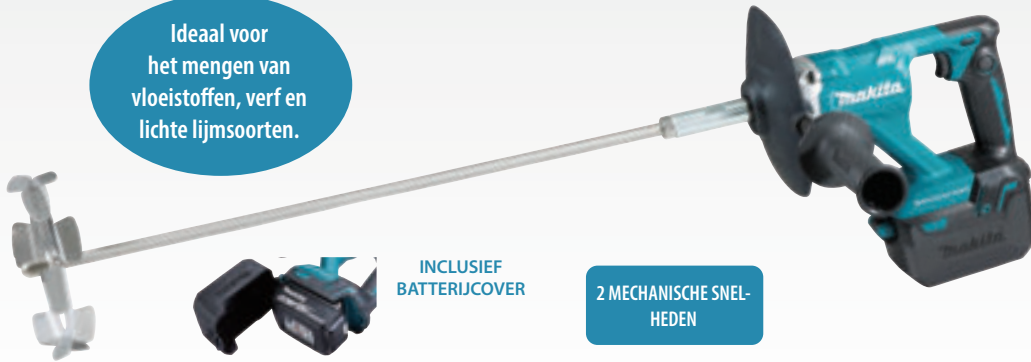

INCLUSIEF BATTERIJCOVER

2 MECHANISCHE SNELHEDEN

DUT130RTE

Spanning	18 V
Bijgeleverde accu's	2 x BL1850B
Diameter mengblad	165 mm
Aansluiting	M12-M14
Toerental	0-350 / 0-1300 t.p.m.
Gewicht	2,5 kg
Prijs in €	excl. btw
	incl. btw

ACCU LANGNEKSCHUURMACHINE 225 MM



Accessoires

Steunschijf

Type	Ref.	Prijs excl. btw	Prijs incl. btw
Zacht	199939-3		
Medium	199940-8		
Hard	199938-5		

Schuurschijf 225 mm (per 25)

Korrel	Ref.	Prijs excl. btw	Prijs incl. btw
P40	B-68389		
P80	B-68395		
P120	B-68404		
P180	B-68410		
P320	B-68426		



Telescopische buis De totale lengte van de machine kan gevarieerd worden van 1100 tot 1520 mm



Verlengstuk

Met het optionele verlengstuk met steun (199937-7) kan langer comfortabel in de hoogte gewerkt worden.

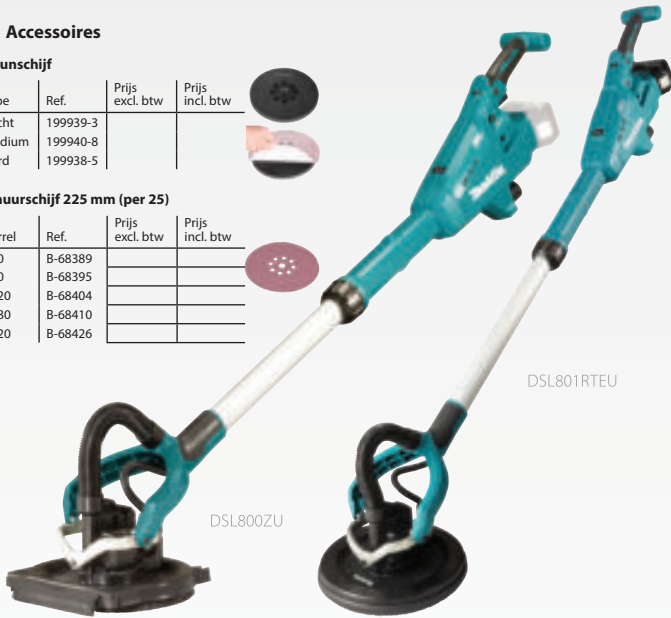

DSL801RTEU

DSL800ZU



De beschermkap van de DSL800 heeft één rechte kant, dat laat toe dicht langs een muur of plafond te bewegen.



De beschermkap van de DSL801 is volledig rond, dit is gunstig voor de stofafvoer.

DSL800ZU DSL801ZU DSL801RTEU

Spanning	18 V	18 V	18 V
Bijgeleverde accu's	0	0	2 x BL1850B
AWS	✓	✓	✓
Toerental onbelast	1000-1800 t.p.m.	1000-1800 t.p.m.	1000-1800 t.p.m.
Diameter schuurschijf	225 mm	225 mm	225 mm
Lengte	1100-1520 mm	1100-1520 mm	1100-1520 mm
Gewicht	4,8 kg	4,8 kg	4,8 kg
Prijs in €	excl. btw		
	incl. btw		

ACCU GIPSFREES



DCO181Z

Spanning	18 V
Bijgeleverde accu's	0
Toerental	0 - 32000 t.p.m.
AWS	✓ excl. Bluetooth unit
BL-Motor	✓
Gewicht	1,4 kg
Prijs in €	excl. btw
	incl. btw

ACCU GIPSAZAG



DSD180ZJ

Spanning	18 V
Bijgeleverde accu's	0
Slaglengte	6 mm
Gewicht	1,7 kg
Prijs in €	excl. btw
	incl. btw

ACCU SCHROEFAUTOMATEN



• **"Push Drive"-technologie:** de motor start automatisch wanneer de neus van de machine tegen de ondergrond wordt gedrukt.



DFR551RTJ



DFR550RTJ

	DFR550RTJ	DFR750Z	DFR452RTJ	DFR551RTJ
Spanning	18V	18V	18V	18V
Bijgeleverde accu's	2xBL1850B	0	2xBL1850B	2xBL1850B
Toerental	4000 t.p.m.	4000 t.p.m.	6000 t.p.m.	6000 t.p.m.
BL motor	-	-	✓	✓
Ø Gipsplaatschroef	4,0 mm	4,0 mm	3,5-4,2 mm	3,5-4,2 mm
Schroeflengte	25-55 mm	45-75 mm	20-41 mm	25-55 mm
"Push drive" technologie	-	-	✓	✓
Gewicht	2,1 kg	2,1 kg	2,2 kg	2,2 kg
Prijs in €	excl. btw			
	incl. btw			

ACCU SCHROEVENDRAAIERS



Duw-aandraaistand ("Push drive")



In de duw-aandraaistand gaan de motor en de schroefkop automatisch draaien wanneer er druk op wordt uitgeoefend.



DFS250RTJ



DFS452FJX2

	DFS250RTJ	DFS452RAJ	DFS452FJX2
Spanning	18 V	18 V	18 V
Bijgeleverde accu's	2 x BL1850B	2 x BL1820B	2 x BL1830B
Toerental	0-2500 t.p.m.	0-4000 t.p.m.	0-4000 t.p.m.
Incl. schroeflintadapter	-	-	✓
Schroeflengte	-	-	25-55 mm
"Push drive" technologie	-	✓	✓
Gewicht	1,5 kg	1,5 kg	1,5 kg
Prijs in €	excl. btw		
	incl. btw		

ACCU BOVEN- EN KANTENFREES



	DRT50ZJX3	DRT50TJX3
Spanning	18 V	18 V
Bijgeleverde accu's	0	2 x BL1850B
Max. induikdiepte	35 mm	35 mm
Toerental onbelast	10.000-30.000 t.p.m.	10.000-30.000 t.p.m.
Ø spatang - bereik	6 - 8 mm	6 - 8 mm
Ø spatang - inbegrepen	6 mm, 8 mm	6 mm, 8 mm
Gewicht	2,1 kg	2,1 kg
Prijs in €	excl. btw	
	incl. btw	

ACCU HANDPALMVLAKSCHUURMACHINES



DBO480RTJ

DBO482RTJ

DBO481RTJ

DBO480: standaard met extra driehoekszool

		DBO480RTJ	DBO481RTJ	DBO482RTJ
Spanning		18 V	18 V	18 V
Afmetingen schuurvoet		112 mm x 102 mm	112 mm x 102 mm	112 mm x 102 mm
Papierbevestiging		Klem/Velcro	Klem	Klem
Materiaal schuurvoet		Kunststof	Kunststof	Aluminium
Aantal schuurbewegingen		22000/28000 min ⁻¹	22000/28000 min ⁻¹	22000/28000 min ⁻¹
Schuuruitslag		1,5 mm	1,5 mm	1,5 mm
Bijgeleverde accu's		2x BL1850B	2x BL1850B	2x BL1850B
Gewicht		1,4-1,8 kg	1,4-1,8 kg	1,4-1,8 kg
Prijs in €	excl. btw			
	incl. btw			

ACCU VLAKSCHUURMACHINES



DBO381RTJU

- Afneembare voorhandgreep

		DBO380RTJ	DBO381RTJU
Spanning		18 V	18 V
Afmetingen schuurvoet		92 mm x 185 mm	92 mm x 185 mm
Aantal schuurbewegingen		8000/16000/24000 min ⁻¹	8000/16000/24000 min ⁻¹
Schuuruitslag		2,0 mm	2,0 mm
AWS		-	✓
Bijgeleverde accu's		2x BL1850B	2x BL1850B
Gewicht		1,9 - 2,2 kg	1,9 - 2,2 kg
Prijs in €	excl. btw		
	incl. btw		

ACCU EXCENTRISCHE SCHUURMACHINE 125 MM



DBO180

		DBO180RTJ
Spanning		18 V
Diameter schuurvoet		125 mm
Aantal schuurbewegingen		14000 - 22000 min ⁻¹
Schuuruitslag		2,8 mm
Bijgeleverde accu's		2 x BL1850B
Gewicht		1,7 kg
Prijs in €	excl. btw	
	incl. btw	

ACCU EXCENTRISCHE POLIJSTMACHINES



DPO500Z

		DPO500Z	DPO600Z
Spanning		18 V	18 V
Oscillatiefrequentie		0-13600 min ⁻¹	0-13600 min ⁻¹
Schuurvoet		125 mm	150 mm
Schuuruitslag		5,5 mm	5,5 mm
Bijgeleverde accu's		0	0
Gewicht		3,1 kg	3,1 kg
Prijs in €	excl. btw		
	incl. btw		

Vrije rotatie en geforceerde rotatie

ACCU BANDSCHUURMACHINE 9 MM



Hoog gebruikskomfort en perfecte balans door centrale plaatsing van de motor

Richtbare led en zijhandgreep



Werkbereik 90° (met uiterste stand 160° voor het opbergen)

		DBS180RTJ
Spanning		18 V
Bandsnelheid		600 - 1700 m/min
Schuurband		9 x 533 mm
Bijgeleverde accu's		2 x BL1850B
Gewicht		1,8 - 2,1 kg
Prijs in €	excl. btw	
	incl. btw	

ACCU MULTITOOL

Wist je dat er van DTM51 de voordelige uitvoeringen DTM51Z en DTM51T1JX2 bestaan? Zie p. 52-53 voor meer info!



STARLOCK



Gereedschapsloze accessoirewissel

DTM51RTJX2

DTM51 Inclusief: set van 9 accessoires, 30 schuurvellen, 1 afzuigset

DTM52

- Compatibel met Starlock, Starlock Plus en Starlock Max accessoires, ideaal voor de zwaardere toepassingen.
- Grote oscillatiehoek van 1,8° links/rechts
- Zeer lage trillingswaarden dankzij AVT technologie
- Kleine greepomtrek en laag gewicht



Promo DTM52RTJX1 : gratis afstandsmeet LD030P



STARLOCK STARLOCK PLUS STARLOCK MAX



DTM52 incl. accessoires

	DTM51RTJX2	DTM52RTJX1
Spanning	18 V	18 V
BL motor	-	✓
Oscillatiefrequentie	6000-20000 /min	10000-20000 /min
Oscillatiehoek	3,2°	3,6°
Opname	OIS, Starlock	Starlock, Starlock Plus, Starlock Max
Bijgeleverde accu's	2 x BL1850B	2 x BL1850B
Gewicht	2,0 kg	1,7 kg
Prijs in €	excl. btw	
	incl. btw	

STARLOCK



STARLOCK PLUS



STARLOCK MAX



Voor het totaal overzicht van het assortiment scan hier

- ✓ Snelle wissel van accessoires door een simpele klik
- ✓ Starlock Plus zaagbladen : snel, diep en veelzijdig invallend zagen
- ✓ Starlock Max zaagbladen : zelfs voor de meest veeleisende en zware toepassingen

- Starlock Plus en Starlock Max accessoires kunnen enkel gebruikt worden met de DTM52.

ACCU SCHUURPOLIJSTMACHINE 75 MM



Polijsten
Steunschijf met velcro opname voor polijst toepassingen.



Compact
Uiterst compacte machine met de handgreep kort bij de schijf voor een optimale controle.

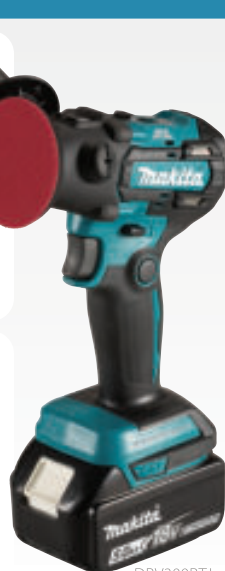

DPV300RTJ

- Zeer compacte machine ideaal voor het schuren en polijsten van kleine oppervlakken.
- Twee mechanische versnellingen en traploze snelheidsregeling.
- Geleverd met velcro steunschijf voor het polijsten en een Roloc™ opname voor schuurtoepassingen.

Accessoires

Steunschijf

Referentie	Omschrijving	Prijs excl. btw	Prijs incl. btw
191N90-9	Inpoetschijf geel		
191N91-7	Inpoetschijf wit		
191N92-5	Wollen polijstschiif		
743125-4	Magic steunschijf om te polijsten 75mm velcro		
743124-6	Roloc steunschijf om te schuren 46mm		
743126-2	Adapter voor Roloc steunschijf 46mm		
140X75-2	Handgreep		
E-07412	Schuurschijf aluminiumoxide 50 mm A60 (25 st.)		
E-07428	Schuurschijf aluminiumoxide 50 mm A80 (25 st.)		
E-07434	Schuurschijf aluminiumoxide 50 mm A120 (25 st.)		
E-07440	Schuurschijf zirconium 50 mm Z60 (25 st.)		
E-07456	Schuurschijf zirconium 50 mm Z80 (25 st.)		
E-07462	Vliesschijf zirconium Grof / Hard 50 mm (25 st.)		
E-07478	Vliesschijf zirconium Medium / Hard 50 mm (25 st.)		
E-07484	Vliesschijf zirconium Fijn / Hard 50 mm (25 st.)		
E-07490	Vliesschijf zirconium Medium / Zacht 50 mm (25 st.)		
E-07509	Vliesschijf zirconium Fijn / Zacht 50 mm (25 st.)		
E-07515	Vliesschijf zirconium Zeer fijn / Zacht 50 mm (25 st.)		



Schuren
Roloc™ compatibele opname voor schuurtoepassingen.

DPV300RTJ

Capaciteit polijsten	80 mm
Capaciteit schuren	50 mm
Toerental polijsten	0-2800 min ⁻¹
Toerental schuren	0-9500 min ⁻¹
Bijgeleverde accu's	2 x BL1850
Gewicht	1,3 kg
Prijs in €	excl. btw
	incl. btw

ACCU BANDZAGEN



DPB180Z

Aluminium behuizing



DPB183



DPB184Z



DPB182Z

	DPB180Z	DPB182Z	DPB184Z	DPB183Z	DPB183RTE
Spanning	18V	18V	18V	18V	18V
Max. bandsnelheid	162 m/min	192 m/min	192 m/min	192 m/min	192 m/min
Capaciteit stalen buis	120 x 120 mm	64 x 64 mm	51 x 51 mm	66 x 66 mm	66 x 66 mm
BL-motor	-	-	✓	✓	✓
Bijgeleverde accu's	-	-	-	-	2 x BL1850B
Bijgeleverde lader	-	-	-	-	DC18RC
Gewicht	6,8 kg	3,8 kg	3,2 kg	3,8 kg	3,8 kg
Prijs in €	excl. btw				
	incl. btw				

ACCU METAALAFKORTMACHINE



DLW140PG2

Gereedschapsloze (hoek)verstelling van de geleider.

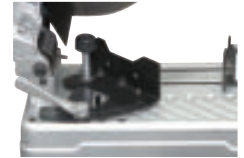

	DLW140Z	DLW140PG2
Spanning	2 x 18V	2 x 18V
Toerental onbelast	3800 t.p.m.	3800 t.p.m.
Diameter schijf	355 mm	355 mm
Bijgeleverde accu's	0	2 x BL1860B
Gewicht	16,9 kg	16,9 kg
Prijs in €	excl. btw	
	incl. btw	

ACCU BLINDKLINKNAGELPISTOLEN



Scan deze code voor uitgebreide technische info.

	DRV150Z	DRV250Z
Trekracht	10 kN	20 kN
Compatibel met blindklinknagel Ø	2,4/3,2/4,0/4,8 mm	4,8/6,0/6,4 mm
Slaglengte	25 mm	30 mm
Bijgeleverde accu's/lader	-	-
Gewicht	1,9 kg	2,1 kg
Prijs in €	excl. btw	
	incl. btw	

ACCU DOORSLIJPER



Dankzij de krachtige en efficiënte BL-motor wordt een uitstekende vermogen-gewichtsverhouding bereikt.

Maximale zaagdiepte 88 mm



ACCESSOIRES

Ref	Type	Prijs excl. btw	Prijs incl. btw
E-03006	Doorslijpschijf RVS 230 x 2,0 x 22,23 mm		
E-02967	Diamantschijf 230 mm x 2,4 x 22,23 mm		



De gesegmenteerde diamantschijf E-02967 werd speciaal ontwikkeld voor het gebruik met een accu doorslijper. De diamantkorrels zijn gelijkmatig verdeeld en volgens een speciaal V-vormig patroon ingebed. Daardoor blijft de schijf continu scherp en zijn de zaagprestaties optimaal.

	DCE090ZX1	DCE090T2X1
Spanning	2 x 18 V	2 x 18 V
Bijgeleverde accu's	0	2 x BL1850B
Lader	-	DC18RD
Ø schijf	230 mm	230 mm
Toerental onbelast	6600 min ⁻¹	6600 min ⁻¹
Max. zaagdiepte	88 mm	88 mm
Max. schijfdikte	3,0 mm	3,0 mm
Gewicht	5,6 - 6,3 kg	5,6 - 6,3 kg
Prijs in €	excl. btw	
	incl. btw	

ACCU DIAMANTZAAG 125 MM



Kantelbaar tot 45°

Inclusief 2 stofkappen, voor droog en nat gebruik

Ideaal voor afwerking (steen, beton, keramiek)



DCC501RTJ



	DCC501RTJ
Spanning	18 V
Toerental onbelast	8500 min ⁻¹
AWS	✓ excl. Bluetooth unit
Diameter asgat	20 mm
Bijgeleverde accu's	2 x BL1850B
Gewicht	2,7 kg
Prijs in €	excl. btw
	incl. btw

ACCU HAAKSE SLIJERS 125 MM

ADT AFT **BL MOTOR**

18V LITHIUM-ION **MAX PAC**

Wist je dat er van DGA506 en DGA508 de voordelige uitvoeringen DGA506Z / DGA506T1J en DGA508Z / DGA508T1J bestaan? Zie p. 52-53 voor meer info!



DGA506RTJ

DGA518RTJU

	DGA506RTJ	DGA508RTJ	DGA513RTJ	DGA514RTJU	DGA517RTJ	DGA518RTJU
Spanning	18V	18V	18V	18V	18V	18V
Bijgeleverde accu's	2 x BL1850B	2 x BL1850B	2 x BL1850B	2 x BL1850B	2 x BL1850B	2 x BL1850B
Ø schijf	125 mm	125 mm	125 mm	125 mm	125 mm	125 mm
Heropstartbeveiliging	✓	✓	✓	✓	✓	✓
Elektrische rem	✓	✓	✓	✓	✓	✓
Regelbaar toerental	-	-	✓	✓	✓	✓
AWS	-	-	-	✓	-	✓
Schakelaar	Schuifschakelaar met vergrendeling	Lepelschakelaar, zonder vergrendeling	Schuifschakelaar met vergrendeling	Schuifschakelaar met vergrendeling	Lepelschakelaar, zonder vergrendeling	Lepelschakelaar, zonder vergrendeling
Gewicht	2,5 kg	2,5 kg	2,5 kg	2,5 kg	2,5 kg	2,5 kg
Prijs in €	excl. btw					
	incl. btw					

BESCHERMKAP MET STOFAFZUIGING VOOR HAAKSE SLIJERS



230 mm



125 mm

	196845-3	198440-5
Diameter stofkap	125 mm	230 mm
Max. zaagdiepte	20 mm	60 mm
Prijs in €	excl. btw	
	incl. btw	

ACCU STEPELSLIJPER

MAX PAC



DGD800RTJ

Spanning	18V
Bijgeleverde accu's	2 x BL1850B
Toerental	25000 t.p.m.
Ø spantang - bereik	6 - 8 mm
Ø spantang - inbegrepen	6 mm
Gewicht	2,1 kg
Prijs in €	excl. btw
	incl. btw

ACCU HAAKSE SLIJERS 180-230 MM

ADT AFT **18V + 18V** **36V**



DGA900PG2

DGA701ZKU

	DGA701ZKU	DGA900ZK	DGA900PG2	DGA901ZKU	DGA901PG2U
Spanning	2 x 18V	2 x 18V	2 x 18V	2 x 18V	2 x 18V
Bijgeleverde accu's	0	0	2 x BL1860B	0	2 x BL1860B
Ø schijf	180 mm	230 mm	230 mm	230 mm	230 mm
AWS	✓	-	-	✓	✓
Gewicht	5,0 kg	5,2 kg	5,2 kg	5,2 kg	5,2 kg
Prijs in €	excl. btw				
	incl. btw				

ACCU HAAKSE SLIJPER 125 MM X-LOCK



DGA519RTJ

DGA521ZX1



Snel en veilig schijven bevestigen via een kliksysteem.



ACCESSOIRES X-LOCK

Referentie	Type	Prijs excl. btw	Prijs incl. btw
E-00393	Afbraamschijf voor metaal 125 mm x 6 x 22,23		
E-00402	Afbraamschijf voor inox 125 mm x 6 x 22,23		
E-00418	Doorslijpschijf voor inox 125 mm x 1,2 x 22,23		
E-02076	Diamantdoorslijpschijf 125 mm		
191G05-4	Beschermkap met stofafzuiging 125 mm		
D-73396	Komborstel voor metaal, gegolfde draad 75 mm x 0,3		
D-73433	Komborstel voor metaal, gegolfde draad, vermessingd 75 mm x 0,3		
D-73346	Komborstel voor inox, gegolfde draad 75 mm x 0,3		
D-73374	Komborstel voor metaal, getordeerde draad 80 mm x 0,35		
D-73380	Komborstel voor metaal, getordeerde draad 80 mm x 0,5		
D-73330	Komborstel voor inox, getordeerde draad 80 mm x 0,5		
D-73449	Kegelborstel voor metaal, gegolfde draad 100 mm x 0,3		
D-73411	Schijfborstel voor metaal, getordeerde draad 115 mm x 0,5		
D-73427	Schijfborstel voor metaal, gegolfde draad 115 mm x 0,3		
E-11776	Doorslijpschijf TCG 125 mm x 2 x 22,23 X-Lock		

	DGA521ZX1	DGA520ZX1	DGA519ZJ	DGA519RTJ
Spanning	18 V	18 V	18 V	18 V
Ø schijf	125 mm	125 mm	125 mm	125 mm
Bijgeleverde accu's	0	0	0	2 x BL1850B
Toerental onbelast	8500 min ⁻¹	8500 min ⁻¹	3000 - 8500 t.p.m.	3000 - 8500 t.p.m.
Heropstartbeveiliging	✓	✓	✓	✓
Elektrische rem	-	✓	✓	✓
Regelbaar toerental	-	-	✓	✓
Type schakelaar	Schuifschakelaar met vergrendeling	Lepelschakelaar zonder vergrendeling	Lepelschakelaar zonder vergrendeling	Lepelschakelaar zonder vergrendeling
Gewicht	2,4 - 3,0 kg	2,4 - 3,0 kg	2,5 kg	2,5 kg
Prijs in €	excl. btw			
	incl. btw			

ACCU KNABBELSCHAAR



DJN161RTJ

Spanning	18 V
Max. aantal snijbewegingen	1900 min ⁻¹
Max. dikte staal	1,6 mm
Bijgeleverde accu's	2 x BL1850B
Gewicht	2,2 kg
Prijs in €	excl. btw
	incl. btw

ACCU PLAATSCHAAREN



DJS130ZJ

DJS131Z

DJS200Z

DJS800Z

bij alle modellen kan de kop 360° gedraaid worden

DJS131: kan bochten en gegolfde staalplaat snijden

DJS200: voor het knippen van rechte stukken met minimale vervorming



DJS800

- Geschikt voor het knippen van o.a. cementbeplating, brandwerende platen en geluidsisolatieplaten tot 13 mm dikte.
- Knipt vrijwel stofvrij, snel en zonder lawaai.
- De snijkop is 360° draaibaar voor knippen op moeilijk bereikbare plaatsen.

NIEUW

	DJS130ZJ	DJS200Z	DJS131Z	DJS800Z
Spanning	18 V	18 V	18 V	18 V
Bijgeleverde accu's	-	-	-	-
BL-motor	-	✓	✓	✓
Aantal zaagbewegingen	2800 min ⁻¹	0-3000 min ⁻¹	0-3000 min ⁻¹	0-3000 min ⁻¹
Max. dikte staal	1,3 mm	2,0 mm	1,3 mm	13 mm (vezelcement)
Gewicht	2,3 - 2,6 kg	2,2 - 2,5 kg	2,0 - 2,3 kg	2,1 - 2,5 kg
Prijs in €	excl. btw			
	incl. btw			

ACCU VLECHTMACHINE



DTR180ZJ



DTR181ZJ

DTR181

- Deze versie kan grotere verbindingen maken, tot bijvoorbeeld: (2 x 16 mm) + (2 x 13 mm) of 25 mm + 22 mm.

Optioneel accessoire:
handgreep 191M27-0



Polyester draad: 191J59-9
(100 m, Ø 0,8 mm) 50 stuks/doos



Vlecht draad gegalvaniseerd: 191A57-9
(100 m, Ø 0,8 mm) 50 stuks/doos



Vlecht draad staal: 199137-9
(100 m, Ø 0,8 mm) 50 stuks/doos

		DTR180ZJ	DTR181ZJ
Spanning		18 V / 14,4 V	18 V / 14,4 V
Bijgeleverde accu's		0	0
Vlechtcapaciteit		10 mm + 10 mm (2 x 13 mm) + (2 x 13 mm)	16 mm + 16 mm (2 x 16 mm) + (2 x 13 mm)
Draaddikte		0,8 mm	0,8 mm
Modus		Enkelvoudig/continu	Enkelvoudig/continu
Gewicht		2,3 kg	2,3 kg
Prijs in €	excl. btw		
	incl. btw		

ACCU VACUÛMPOMP



DVP181

- Kan continu werken dankzij twee accu's in parallel
- Tweetraps pomp met hoog debiet



DVP181ZK



DVP180Z

		DVP180Z	DVP181ZK
Spanning		18 V	18 V, 2 accu's in parallel
Bijgeleverde accu/lader		-	-
Compressor		ééntraps olieafgedichte schottenpomp	Tweetraps olieafgedichte schottenpomp
Debiet		60 l/min	113 l/min
Eindvacuüm		20 Pa (150 micron)	3 Pa (22,5 micron)
Gewicht		2,9 kg	8,2 kg
Prijs in €	excl. btw		
	incl. btw		

ACCU KITPISTOOL



INCLUSIEF
kokerhouder
600 ml bij
DCG180RAX



300 ML

300 ML

600 ML

DCG180RAX

		DCG180RA	DCG180RAX
Spanning		18 V	18 V
Bijgeleverde accu's		1 x BL1820B	1 x BL1820B
Max. spuitdruk		5000 N	5000 N
Max. extrusiesnelheid		0-28 mm/s	0-28 mm/s
Gewicht		2,1 kg	2,4 kg
Prijs in €	excl. btw		
	incl. btw		

Voor gebruiksklaar afkorten zonder vonken

Mobiel afkorten



DSC102ZJ



DSC121ZK

Stationair afkorten



DSC102

	DSC102ZJ	DSC121ZK
Spanning	18 V	18 V
Bijgeleverde accu's	0	0
Snijcapaciteit	M6/M8/M10	M8/M10/M12
Inbegrepen messenset	M8/M10	M8
Gewicht	3,3 kg	5,7 kg
Prijs in €	excl. btw	
	incl. btw	

ACCU BETONIJSERZAAG



DSC251ZK

Spanning	18 V
Bijgeleverde accu's/lader	0
Snijcapaciteit	10-25 mm
Gewicht	3,9 kg
Prijs in €	excl. btw
	incl. btw

ACCU HYDRAULISCHE BETONIJSERKNIPPERS



DSC163ZK

DSC163ZK DSC191Z

Spanning	18 V	18 V
Bijgeleverde accu's/lader	-	-
Snijcapaciteit	3 - 16 mm	3 - 20 mm
BL-motor	✓	-
Gewicht	6,9 kg	11,1 - 11,2 kg
Prijs in €	excl. btw	
	incl. btw	

ACCU PONSMACHINE



DPP200ZK

Spanning	18 V
Max. diameter ponsgat	20 mm
Inbegrepen Ø	12 mm
Max. dikte staal	8 mm
Max. dikte inox	6 mm
Gewicht	10,5 kg
Prijs in €	excl. btw
	incl. btw

Werkt met standaard
400g patronen of vet
in bulk



Debietregeling:
automatisch of traag
(met hoogste druk)



DGP180RT

Hogedrukslang
van 120 cm



DGP180Z

	DGP180Z	DGP180RT
Spanning	18V	18V
Bijgeleverde accu's	-	1 x BL1850B
Maximale druk	690 bar	690 bar
Debiet	145-290 ml/min	145-290 ml/min
Gewicht	4,8 kg	4,8 kg
Prijs in €	excl. btw	
	incl. btw	



DVR850Z



- Voeding middels PDC01/PDC1200 draagbaar accupack (accupack niet inbegrepen)
- Zeer comfortabel werken omdat enkel de trilnaald gehanteerd moet worden.
- Compatibel met flessen met grote diameter Ø 43 mm en Ø 52 mm
- Werktijd tot 300 minuten met PDC1200



VR004C



VR001C

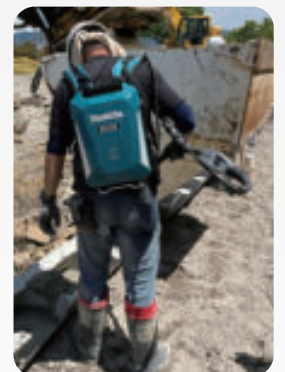

	DVR350Z	DVR450Z	DVR850Z
Spanning	18V	18V	18V
Bijgeleverde accu's	0	0	0
Lengte trilnaald	80 cm	120 cm	240 cm
Diameter trilnaald	25 mm	25 mm	25 mm
Gewicht	2,0 kg	2,3 kg	2,4 kg
Prijs in €	excl. btw		
	incl. btw		

	NIEUW VR001CZ	NIEUW VR002CZ	NIEUW VR003CZ	NIEUW VR004CZ
Spanning	36V (Direct connect)	36V (Direct connect)	36V (Direct connect)	36V (Direct connect)
Bijgeleverde accu's	-	-	-	-
Trilfrequentie	1200 min ⁻¹	1200 min ⁻¹	1200 min ⁻¹	1200 min ⁻¹
Ø trilflles	43 mm	43 mm	52 mm	52 mm
Lengte trilnaald	1,5 m	3,0 m	1,5 m	3,0 m
Autonomie (PDC1200)	300 min	300 min	200 min	200 min
Gewicht	11,8 kg	12,9 kg	12,6 kg	13,7 kg
Prijs in €	excl. btw			
	incl. btw			

BESPAAR MET ONZE COMBOPACKS

PROMO

Gratis extra BL1830B bij al deze combopacks

MACHINES IN COMBOPACK 18 V		MACHINES 2 x 18 V	ACCU	DC18RC	MAK-PAC	PRIJS IN €
			1 x 			DLX2375T
			3 x 			DLX2289T3J
			3 x 			DLX2189T3J
			2 x 			DLX2440TJ
			3 x 			DLX2236TJ1
			3 x 		2 x 	DLX2235T3J
			3 x 			DLX2434TJ
			4 x 		3 x 	DLX2194PTJ
			3 x 			DLX2245PT1



BESPAAR MET ONZE COMBOPACKS

	DHP486	DTD153	DHR243	DGA506	DHS660	DJV181	DTM51
DLX2418TJ							
DLX4159TJ							
DLX5070TJ							
DLX5071TJ							
DLX6115JX1							
DLX1036TJ1							
DLX1108TJ1							

PROMO

Gratis batterij BL1850B
meteen mee geleverd
in de Makpac!

Combineer voordelig
met deze aanbieding

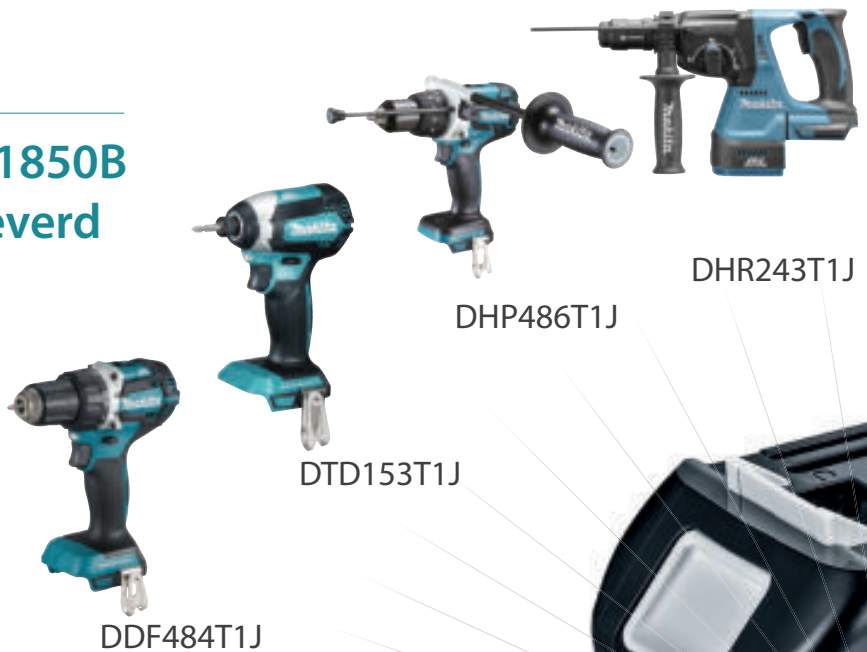

DDF484T1J

DTD153T1J

DHP486T1J

DHR243T1J

DTM51T1JX2





TR0000001 TROLLEY



DJR188Z	DRT50ZJX3	DBO180ZJ	DDA351ZJ	BL1850B 18 V 5,0 Ah	DC18RC	KOFFER	PROMO	PRIJS IN €
				3 x 			PROMO BL1840B	
				3 x 		2 x	PROMO BL1840B	
				3 x 		3 x	PROMO BL1840B	
				3 x 		3 x	PROMO BL1840B	
				3 x 		4 x	PROMO 2x BL1840B	
				5 x 	2 x 	9 x	PROMO 2x BL1840B	
				5 x 	2 x 	10 x	PROMO 2x BL1840B	



DHS680T1J



DTW300T1J



DJV181T1J



DJV182T1J

DGA506T1J



DGA508T1J



Deze modellen bestaan ook in een voordelige 'Z-versie' zonder accu, lader, Makpac of andere extra toebehoren.



HET LXT -PLATFORM

DBN500ZJ

Minibradpistool 18 V

Prijs excl. BTW Prijs incl. BTW



Makpac

DBN600ZJ

Bradpistool 18 V

Prijs excl. BTW Prijs incl. BTW



Makpac

DBO180ZJ

Excentrische schuurmachine 18 V

Prijs excl. BTW

Prijs incl. BTW



Makpac

DBO380ZJ

Vlakschuurmachine 18 V

Prijs excl. BTW

Prijs incl. BTW



Makpac

DBO381ZJU

Vlakschuurmachine 18 V

Prijs excl. BTW

Prijs incl. BTW



Makpac

DBO480ZJ

Vlakschuurmachine 18 V

Prijs excl. BTW

Prijs incl. BTW



Makpac

DBO481ZJ

Vlakschuurmachine 18 V

Prijs excl. BTW

Prijs incl. BTW



Makpac

DBO482ZJ

Vlakschuurmachine 18 V

Prijs excl. BTW

Prijs incl. BTW



Makpac

DBS180ZJ

Bandschuurmachine 9 mm 18 V

Prijs excl. BTW

Prijs incl. BTW



Makpac

DCB200B

Verwarmd deken 18 V

Prijs excl. BTW

Prijs incl. BTW



Karton

DCC501ZJ

Diamantzaag 125 mm 18 V

Prijs excl. BTW

Prijs incl. BTW



Makpac

DCG180ZK

Kitpistool 18 V

Prijs excl. BTW

Prijs incl. BTW



Koffer

DCG180ZXK

Kitpistool 18 V incl. kokerhouder

Prijs excl. BTW

Prijs incl. BTW



Koffer

DCO181Z

Gipsfrees 18 V

Prijs excl. BTW

Prijs incl. BTW



Karton

DCS552ZJ

Metaalcirkelzaag 18 V

Prijs excl. BTW

Prijs incl. BTW



Makpac

DCS553ZJ

Metaalcirkelzaag 18 V

Prijs excl. BTW

Prijs incl. BTW



Makpac

DDA351ZJ

Haakse boormachine 18 V

Prijs excl. BTW

Prijs incl. BTW



Makpac

DDA450ZK

Haakse boormachine 18 V

Prijs excl. BTW

Prijs incl. BTW



Koffer

DDF083ZJ

Boor- en schroefmachine 1/4" 18 V

Prijs excl. BTW

Prijs incl. BTW



Makpac

DDF482ZJ

Boor- en schroefmachine 18 V

Prijs excl. BTW

Prijs incl. BTW



Makpac

DDF484Z

Boor- en schroefmachine 18 V

Prijs excl. BTW

Prijs incl. BTW



Karton

DDF485ZJ

Boor- en schroefmachine 18 V

Prijs excl. BTW

Prijs incl. BTW



Makpac

DDF486ZJ

Boor- en schroefmachine 18 V

Prijs excl. BTW

Prijs incl. BTW



Makpac

DFN350ZJ

Minibradpistool 18 V

Prijs excl. BTW

Prijs incl. BTW



Makpac

DFR452ZJ

Schroefautomaat 18 V

Prijs excl. BTW

Prijs incl. BTW



Makpac

DFR550ZJ

Schroefautomaat 18 V

Prijs excl. BTW

Prijs incl. BTW



Makpac

DFR551ZJ

Schroefautomaat 18 V

Prijs excl. BTW

Prijs incl. BTW



Makpac

DFR750Z

Schroefautomaat 18 V

Prijs excl. BTW

Prijs incl. BTW



Karton

DFS250ZJ

Schroefmachine 18 V

Prijs excl. BTW

Prijs incl. BTW



Makpac

DFS452ZJ

Schroefmachine 18 V

Prijs excl. BTW

Prijs incl. BTW



Makpac

DGA506Z

Haakse slijper 125 mm 18 V

Prijs excl. BTW

Prijs incl. BTW



Karton

DGA508Z

Haakse slijper 125 mm 18 V

Prijs excl. BTW

Prijs incl. BTW



Karton

DGA513ZJ

Haakse slijper 125 mm 18 V

Prijs excl. BTW

Prijs incl. BTW



Makpac

DGA514ZJU

Haakse slijper 125 mm 18 V

Prijs excl. BTW

Prijs incl. BTW



Makpac

DGA517ZJ

Haakse slijper 125 mm 18 V

Prijs excl. BTW

Prijs incl. BTW



Makpac

DGA518ZJU

Haakse slijper 125 mm 18 V

Prijs excl. BTW

Prijs incl. BTW



Makpac

DGA519ZJ

Haakse slijper 125 mm X-lock 18 V

Prijs excl. BTW

Prijs incl. BTW



Makpac

DGA520ZX1

Haakse slijper 125 mm X-lock 18 V

Prijs excl. BTW

Prijs incl. BTW



Karton

DGA521ZX1

Haakse slijper 125 mm X-lock 18 V

Prijs excl. BTW

Prijs incl. BTW



Karton

DGD800ZJ

Stempelslijper 18 V

Prijs excl. BTW

Prijs incl. BTW



Makpac

DGP180Z

Vetpomp 18 V

Prijs excl. BTW

Prijs incl. BTW



Karton

DHG180ZJ

Heteluchtpistool 18 V

Prijs excl. BTW

Prijs incl. BTW



Makpac

DHG181ZJ

Heteluchtpistool 18 V

Prijs excl. BTW

Prijs incl. BTW



Makpac

DHP484ZJ

Klopboor- en schroefmachine 18 V

Prijs excl. BTW

Prijs incl. BTW



Makpac

DHP485ZJ

Klopboor- en schroefmachine 18 V

Prijs excl. BTW

Prijs incl. BTW



Makpac

DHP486Z

Klopboor- en schroefmachine 18 V

Prijs excl. BTW

Prijs incl. BTW



Karton

DHR171ZJ

SDS-PLUS Boorhamer 18 V

Prijs excl. BTW

DHR243ZJW

SDS-PLUS Boorhamer 18 V + DX07
Prijs excl. BTW



Prijs incl. BTW

Makpac

DHR264ZJ

Combiamer SDS+ 2 x 18 V
Prijs excl. BTW



Prijs incl. BTW

Makpac

DHS630ZJ

Cirkelzaag 165 mm 18 V
Prijs excl. BTW



Prijs incl. BTW

Makpac

DHS660ZJ

Cirkelzaag 165 mm 18 V
Prijs excl. BTW



Prijs incl. BTW

Makpac

DHS661ZJU

Cirkelzaag 165 mm 18 V
Prijs excl. BTW



Prijs incl. BTW

Makpac

DHS680Z

Cirkelzaag 165 mm 18 V
Prijs excl. BTW



Prijs incl. BTW

Karton

DHS710ZJ

Cirkelzaag 190 mm 2 x 18 V
Prijs excl. BTW



Prijs incl. BTW

Makpac

DHS782ZJ

Cirkelzaag 190 mm 2 x 18 V
Prijs excl. BTW



Prijs incl. BTW

Makpac

DHS783ZJU

Cirkelzaag 190 mm 2 x 18 V
Prijs excl. BTW



Prijs incl. BTW

Makpac

DHS900Z

Cirkelzaag 235 mm 2 x 18 V
Prijs excl. BTW



Prijs incl. BTW

Karton

DHS900ZU

Cirkelzaag 235 mm 2 x 18 V
Prijs excl. BTW



Prijs incl. BTW

Karton

DJN161ZJ

Knabbelschaar 18 V
Prijs excl. BTW



Prijs incl. BTW

Makpac

DJR183ZJ

Reciprozaag 18 V
Prijs excl. BTW



Prijs incl. BTW

Makpac

DJR186ZK

Reciprozaag 18 V
Prijs excl. BTW



Prijs incl. BTW

Koffer

DJR187ZK

Reciprozaag 18 V
Prijs excl. BTW



Prijs incl. BTW

Koffer

DJR188ZJ

Reciprozaag 18 V
Prijs excl. BTW



Prijs incl. BTW

Makpac

DJR189ZJ

Reciprozaag 18 V
Prijs excl. BTW



Prijs incl. BTW

Makpac

DJR360ZK

Reciprozaag 2 x 18 V
Prijs excl. BTW



Prijs incl. BTW

Koffer

DCV202ZL

Bodywarmer 18 V (maat: L)
Prijs excl. BTW



Prijs incl. BTW

Makpac

DCJ205ZL

Verwarmde jas 18 V (maat: L)
Prijs excl. BTW



Prijs incl. BTW

Karton

DCJ206ZXL

Verwarmde jas 18 V (maat: XL)
Prijs excl. BTW



Prijs incl. BTW

Karton

DJV181Z

Decoupeerzaag 18 V
Prijs excl. BTW



Prijs incl. BTW

Karton

DJV182Z

Decoupeerzaag 18 V
Prijs excl. BTW



Prijs incl. BTW

Karton

DJV184Z

Decoupeerzaag 18 V
Prijs excl. BTW



Prijs incl. BTW

Karton

DJV185Z

Decoupeerzaag 18 V
Prijs excl. BTW



Prijs incl. BTW

Karton

NIEUW**DKP181ZU**

Schaaf 18 V
Prijs excl. BTW



Prijs incl. BTW

Karton

DLS600Z

Afkort-verstekzaag 165 mm 18 V
Prijs excl. BTW



Prijs incl. BTW

Karton

DPJ180ZJ

Lamellenfrees 18 V
Prijs excl. BTW



Prijs incl. BTW

Makpac

DPT353ZJ

Afwerkingpistool 18 V
Prijs excl. BTW



Prijs incl. BTW

Makpac

DPV300ZJ

Schuur- en polijst-machine 75 mm 18 V
Prijs excl. BTW



Prijs incl. BTW

Makpac

DRT50ZJ

Boven- en kantenfrees 18 V
Prijs excl. BTW



Prijs incl. BTW

Makpac

DRV150ZJ

Blindklinknagelpistool 18 V
Prijs excl. BTW



Prijs incl. BTW

Makpac

DRV250ZJ

Blindklinknagelpistool 18 V
Prijs excl. BTW



Prijs incl. BTW

Makpac

DSD180ZJ

Gipszaag 18 V
Prijs excl. BTW



Prijs incl. BTW

Makpac

DSP600ZJ

Invalcirkelzaag 165 mm 2 x 18 V
Prijs excl. BTW



Prijs incl. BTW

Makpac

DSS501ZJ

Cirkelzaag 136 mm 18 V
Prijs excl. BTW



Prijs incl. BTW

Makpac

DST112ZJ

Nietmachine 18 V
Prijs excl. BTW



Prijs incl. BTW

Makpac

DST221ZJ

Nietmachine 18 V
Prijs excl. BTW



Prijs incl. BTW

Makpac

DTD153Z

Slagschroevendraaier 18 V
Prijs excl. BTW



Prijs incl. BTW

Karton

DTD154ZJ

Slagschroevendraaier 18 V
Prijs excl. BTW



Prijs incl. BTW

Makpac

DTD156Z

Slagschroevendraaier 18 V
Prijs excl. BTW



Prijs incl. BTW

Karton

DTD157ZJ

Slagschroevendraaier 18 V
Prijs excl. BTW



Prijs incl. BTW

Makpac

DTD172ZJ

Slagschroevendraaier 18 V
Prijs excl. BTW



Prijs incl. BTW

Makpac

DTL061ZJ

Haakse slagschroevendraaier 18 V
Prijs excl. BTW



Prijs incl. BTW

Makpac

DTM51Z

Multitool 18 V
Prijs excl. BTW



Prijs incl. BTW

Karton

DTM52ZJ

Multitool 18 V
Prijs excl. BTW



Prijs incl. BTW

Makpac

DTW1001ZJ

Slagmoersleutel 18 V
Prijs excl. BTW



Prijs incl. BTW

Makpac

DTW1002ZJ

Slagmoersleutel 18 V
Prijs excl. BTW



Prijs incl. BTW

Makpac

DTW180ZJ

Slagmoersleutel 18 V
Prijs excl. BTW



Prijs incl. BTW

Makpac

DTW181ZJ

Slagmoersleutel 18 V
Prijs excl. BTW



Prijs incl. BTW

Makpac

DTW190ZJ

Slagmoersleutel 18 V
Prijs excl. BTW



Prijs incl. BTW

Makpac

DTW300Z

Slagmoersleutel 18 V
Prijs excl. BTW



Prijs incl. BTW

Karton

DTW700ZJ

Slagmoersleutel 18 V
Prijs excl. BTW



Prijs incl. BTW

Makpac

DUT130Z

Menger 18 V
Prijs excl. BTW



Prijs incl. BTW

Karton

DWT310ZK

Breekmoersleutel 2 x 18 V
Prijs excl. BTW



Prijs incl. BTW

Koffer

ACCU KOFFIEZETAPPARAAT



Ideaal voor op de bouw- en werkplaats. Werkt zowel met koffiepads als met gemalen koffie. Met één accu (LXT 5,0 Ah) maak je 3 koppen koffie van 160 ml.

DCM501Z

Spanning	10,8V/14,4V/18V	
Inhoud waterreservoir	240 ml	
Bereidingstijd met 18V accu (150 ml)	5 min.	
Bijgeleverde accu's	0	
Gewicht	1,9 - 2,2 kg	
Prijs in €	excl. btw	
	incl. btw	



PROMO
Inclusief:
BL1830

ACCU WATERKOKER



- Dubbellaagse roestvrijstalen wand
- Met voedingsstandaard en groot handvat
- Uitgerust met morsbeveiliging

DKT360Z

Spanning	2x18V	
Inhoud	0,8 l	
Kooktijd voor 0,8 l	ca. 8 min	
Verwarmcapaciteit 100 °C	1,2 l met 2 x BL1850	
Gewicht	2,7 - 3,4 kg	
Prijs in €	excl. btw	
	incl. btw	

LUCHTPOMP



DMP180Z



Standaard met verschillende ventieladapters



Bedieningspaneel

De DMP181 is uitgerust met een groot display met achtergrondverlichting.



DMP181Z

DMP181

- Drie modi: hoog debiet, laag debiet en "ball" mode om op een veilige manier speelballen op te blazen.
- Functie voor het aflaten van lucht indien de druk te hoog is.

DMP180Z DMP181Z

Spanning	18V	18V
Debiet	10 l/min	11 - 22 l/min
Max. druk	8,3 bar	11,1 bar
Bijgeleverde accu/lader	-	-
Gewicht	1,5 kg	2,5 - 2,8 kg
Prijs in €	excl. btw	
	incl. btw	

BLAAS- EN ZUIGMACHINE



DAS180RT

- Traploos regelbare snelheid met vario-schakelaar en voorkeuze van 4 maximumsnelheden.
- Verschillende mondstukken beschikbaar voor uiteenlopende toepassingen. Standaard worden 5 mondstukken meegeleverd.
- Kan ook gebruikt worden om lucht weg te zuigen via een speciaal opzetstuk (optioneel).
- Ideaal voor het reinigen van gereedschap en onderdelen. Kan ook gebruikt worden om bijvoorbeeld speelgoed voor op het water op te blazen of snel af te laten.



NIEUW NIEUW

DAS180Z DAS180RT

Spanning	18V	18V
Bijgeleverde accu	-	1x BL1850B
Max. debiet	1,1 m³/min	1,1 m³/min
Blaaskracht	2,8 N	2,8 N
Max. onderdruk	93 mbar	93 mbar
Gewicht	1,2 - 1,7 kg	1,2 - 1,7 kg
Prijs in €	excl. btw	
	incl. btw	

ACCU GEVENTILEERDE VESTEN



Bescherm uzelf tegen de hitte met onze geventileerde vesten op accu!



DFV210Z

Polyester
Waterafstotend
DFV210
Zijdellingse ventilatoren



DFV214A01

**DFV214A01 (S-L) /
DFV214A01 (XL-3XL)**
Zijdellingse ventilatoren



DFJ212Z

Polyester
Waterafstotend
DFJ212
Zijdellingse ventilatoren



DFJ210Z

DFJ211Z

Polyester
Waterafstotend en
vochtdoorlatend
DFJ210/211 (met kap)
Zijdellingse ventilatoren
/
/



DFJ213Z

Polyester
Stretch
DFJ213
Zijdellingse ventilatoren



DFJ304Z

Katoen
Vochtabsorberend
DFJ304
Zijdellingse ventilatoren



DFJ214Z

Polyester
Waterafstotend en
antistatisch
DFJ214
Zijdellingse ventilatoren



DFJ410Z

DFJ411Z

Polyester met
titanium coating
UV- en IR-reflecterend -
stretch
DFJ410/DFJ411 (met kap)
Zijdellingse ventilatoren
/
/

	maat (cm)	S	M	L	XL	2XL	3XL
■ DFJ212	Lengte			70	71	72	73
	Schouder			48	50	52	54
	Mouw*			93	95	97	99
	Borst			127	132	137	142
	Taille			121	126	131	136
■ DFJ213	Lengte			69	70	71	72
	Schouder			51	53	55	57
	Mouw			66	67	68	69
	Borst			127	132	137	142
	Taille			113 ~ 121	118 ~ 126	123 ~ 131	128 ~ 136
■ DFJ214	Lengte			72	73	74	75
	Schouder			51	53	55	57
	Mouw			66	67	68	69
	Borst			127	132	137	142
	Taille			113 ~ 121	118 ~ 126	123 ~ 131	128 ~ 136
■ DFJ210/DFJ211	Lengte	64	66	68	70	72	74
	Schouder	51.55	4	56.55	9	61.56	4
	Mouw	54	56	58	60	62	64
	Borst	116	121	126	131	136	141
	Taille	77 ~ 108	82 ~ 113	87 ~ 113	92 ~ 133	97 ~ 113	102 ~ 133
■ DFJ410/DFJ411	Lengte			71	72	73	74
	Schouder			47	49	51	53
	Borst			123	128	133	138
	Taille			117	122	127	132

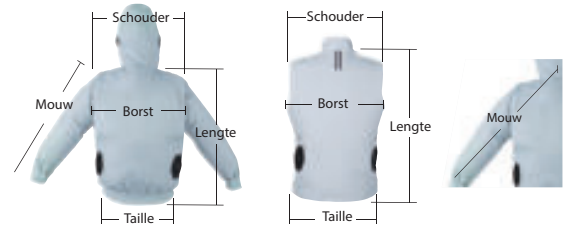

NIEUW
DEABL1055B
Powerbank



198634-2
Accu-adaptor LXT-batterijen



198639-2
Accu-adaptor CXT-batterijen

ACCU VENTILATOREN



DCF301

- Hoge luchtsnelheid en stille werking
- Afneembare bescherming voor gemakkelijk reinigen



DCF301Z



DCF203Z



DCF102Z

	DCF102Z	DCF203Z	DCF301Z
Spanning	18V / 14,4V	18V / 14,4V	18V / 14,4V
AC adapter	Optioneel	Optioneel	inclusief
Diameter	180 mm	235 mm	300 mm
Auto zwenken L/R	✓	✓	✓
Timer	✓	✓	✓
Gewicht	1,3 kg	2,5 kg	4,3 kg
Prijs in €	excl. btw		
	incl. btw		

ACCU BLUETOOTH-SPEAKERS

12V^{max}
LITHIUM-ION

18V^{max}
LITHIUM-ION



USB

Bluetooth

DMR202
BLUETOOTH-SPEAKER
MET MEDIASPELER

LCD-display

USB-
mediaspeler



Bluetooth

DMR203
BLUETOOTH-SPEAKER
MET KOPPELFUNCTIE

Equalizer

Koppelbaar
per 2: True Wireless Stereo
tot 10: simultaan luisteren

ACCU RADIO'S

XGT
40V^{Li-ION}
max

12V^{max}
LITHIUM-ION

14.4V^{max}
LITHIUM-ION

18V^{max}
LITHIUM-ION



MR03GZ
WERFRADIO
XGT/ LXT



MR04GZ
WERFRADIO
XGT/ LXT



MR07GZ
WERFRADIO
XGT/ LXT



DMR301
WERFRADIO
CXT/LXT



DMR056
RADIO MET
LANTAARN LXT



MR009GZ
RADIO MET
LANTAARN XGT



GEREEDSCHAPSETS IN KOFFER

Onze favoriet!
E-10883 : 221-delige gereedschapskoffer voor kleine herstellingen



Scan mij voor meer info!



E-10883
GEREEDSCHAPSET
221-DELIG

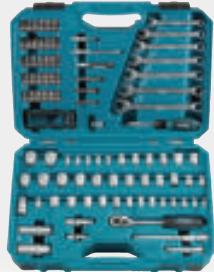

E-06616
GEREEDSCHAPSKOFFER
120-DELIG

MAKPAC OPBERGSYSTEEM



191X80-2
395 x 295 x 110 mm
2.3 kg

- Inclusief 5 types van bakjes : 150x150 mm (1), 150x100 mm (1), 100x100 mm (2), 100x50 mm (3) en 50x50 mm (6)
- Bijkomende inzetbakjes zijn apart te verkrijgen
- Flexibel indeelbaar
- Koppelbaar met Makita Makpacs, Makstors, Makpac trolley TR00000001 en Makpac transportkar P-83886

MAKSTORS



P-84311 Makstor nr. 3 met 4 lades.



P-84333 Makstor nr. 3 met 6 lades



P-84327 Makstor nr. 3 met 12 lades



P-84349 Makstor nr. 4 met 5 lades

Koppelbaar met alle Makita Makpacs, alsook met Makpac IV koelbox 198253-4, de Makpac trolley TR00000001 en de Makpac transportkar P-83886

De lades van de Makstor zijn flexibel indeelbaar. Standaard worden er bij deze Makstor 8 verdelers / tussenschotten geleverd. De lades zijn voorzien van een vergrendelingssysteem en kunnen gelabeld worden

IDEAAL OM LOSSE SPULLEN IN TE BEWAAREN ZOALS BOREN EN BITSEN

Omschrijving	Ref.	Indeling	Afmetingen	Prijs excl. btw	Prijs incl. btw
Makstor nr. 3-4	P-84311	4 lades (1 groot / 2 klein / 1 middelgrote)	395 (L) x 295 (B) x 210 (H) mm		
Makstor nr. 3-12	P-84327	12 kleine lades	395 (L) x 295 (B) x 210 (H) mm		
Makstor nr. 3-6	P-84333	6 middelgrote lades	396 (L) x 295 (B) x 210 (H) mm		
Makstor nr. 4-5	P-84349	5 lades (2 groot / 2 klein / 1 middelgrote)	395 (L) x 295 (B) x 320 (H) mm		

LAMPEN

ZAKLAMPEN CXT



	DEAML103	DEAML104	DEAML105	DEAML106
Spanning	10,8 V (12Vmax)	10,8 V (12Vmax)	10,8 V (12Vmax)	10,8 V (12Vmax)
Max. lichtstroom	100 lm	710 lm	190 lm	190 lm
Verlichtingssterkte op 1 m	50 lx	340 lx (0,5 m, lantaarn)	5500 lx	170 - 4500 lx
Werkingsduur bij max intensiteit, accu BL1041B	28 u.	5,5 u.	14 u.	12 u.
Specifieke functionaliteiten	Uiterst compact	Lantaarn (360°) en zaklamp (gericht) USB uitgang	Reflector in 12 posities verstelbaar	Zoom functie
Afmetingen	77 x 54 x 28 mm	414 x 66 x 132 mm	249 x 66 x 93 mm	271 x 66 x 93 mm
Gewicht	0,27 - 0,43 kg	0,61 - 0,78 kg	0,53 - 0,7 kg	0,61 - 0,78
Prijs in €	excl. btw			
	incl. btw			

ZAKLAMPEN XGT



	DEAML001G	DEAML002G	DEAML006G	DEAML007G
Spanning	36 V (40Vmax)	36 V (40Vmax)	36 V (40Vmax)	36 V (40Vmax)
Max. lichtstroom	160 lm	710 lm	500 lm	1000 lm (flood)
Verlichtingssterkte op 1 m	3000 lx	340 lx	800 lx	520 lx (flood)
Werkingsduur bij max. intensiteit, accu BL4025	34 u.	10 u.	12,5 u	6,5 u (flood)
Specifieke functionaliteiten	Reflector in 12 posities kantelbaar	Lantaarn (360°) en zaklamp (gericht) USB uitgang	Reflector draaibaar en kantelbaar	Modi: spot, flood, spot + flood
Afmetingen	281 x 88 x 121 mm	370 x 86 x 126 mm	402 x 85 x 134 mm	273 x 120 x 106 mm
Gewicht	1,0 - 1,3 kg	1,2 - 1,5 kg	1,1 - 1,7 kg	1,6 - 2,9 kg
Prijs in €	excl. btw			
	incl. btw			

DEADML105 - DEADML815 - DEAML001G
Reflector 170° kantelbaar in 12 stappen

170°



DEADML104 - DEBDML806 - DEBDML807 - DEAML002G

3 modi: 360° zijdelings licht, 180° zijdelings licht en gericht licht (bovenaan).
USB uitgang Type A: 5V 2,4 A (behalve DEBDML806)

3 MODI

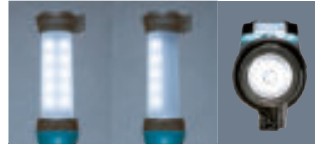

USB uitgang



BEADML810

Ontwerp met laag zwaartepunt zodat de lamp niet kan omvallen



WERFLAMPEN LXT



	DEADML805	DEADML811	DEADML809	BEADML810	DML813	DML814
Spanning	18 V / 14,4 V / AC	18 V / 14,4 V / AC	18 V / 14,4 V / AC	18 V / 14,4 V / AC	18 V / 14,4 V	18 V / 14,4 V
Max. lichtstroom	750 lm	3000 lm	10000 lm	5500 lm	3000 lx	3000 lx
Verlichtingssterkte op 1 m	300 lx	1800 lx	3800 lx	550 lx	1250 lx	1250 lx
Verlichtingssterkte op 3 m	-	200 lx	380 lx	70 lx	130 lx	130 lx
Verlichtingssterkte op 5 m	-	85 lx	150 lx	25 lx	50 lx	50 lx
Verlichtingscapaciteit naar voor/zijdelings	-	6 m/6 m	10 m/10 m	360°, ± 4 m	4,5 m/5,3 m	4,7 m/5,6 m
Werkingsduur bij max intensiteit, accu BL1850B	8,5 u.	3 u.	1,4 u (2x BL1850B)	3,5 u.	3 u. (2x BL1850B)	3 u. (2x BL1850B)
Specifieke functionaliteiten	DC/AC 2 helderheidsniveaus	DC/AC 3 helderheidsniveaus	DC/AC 3 helderheidsniveaus	DC/AC 3 helderheidsniveaus	Geïntegreerd statief	Geïntegreerd statief Met 3 afzonderlijk richtbare lichtunits
Afmetingen	214 x 261 x 328 mm	249 x 302 x 361 mm	249 x 379 x 370 mm	420 x 420 x 787 mm	573 x 658 x 1250-2240 mm	573 x 658 x 1250-2240 mm
Gewicht	2,3 - 2,7 kg	4,1 - 4,8 kg	5,7 - 7,0 kg	13,9 - 15,3 kg	7,2 - 7,9 kg	7,4 - 8,1 kg
Prijs in €	excl. btw					
	incl. btw					

DML813-DML814

Uitschuifbaar van 1250 mm tot 2240 mm
Gemakkelijk opvouwbaar voor transport



ZAKLAMPEN LXT



	DEADML803	DEBDML186	DEBDML800	DEBDML815	DEBDML808	DEBDML801	DEADML816	DEBDML806	DECDML807	DEBDML812
Spanning	18V/ 14,4V	18V/ 14,4V	18V/ 14,4V	18V/ 14,4V	18V/ 14,4V	18V/ 14,4V	18V/ 14,4V	18V/ 14,4V	18V/ 14,4V	18V/ 14,4V
Max. lichtstroom	170 lm	-	100 lm	160 lm	190 lm	240 lm	500 lm	620 lm (lantaarn)	710 lm (lantaarn)	1000 lm (flood)
Verlichtingssterkte op 1 m	270 lx (0,5 m)	500 lx	2000 lx	3000 lx	170 - 4500 lx	400 lx (0,5 m)	800 lx (1m)	310 lx (0,5 m, lantaarn)	340 lx (0,5 m, lantaarn)	520 lx (0,5 m flood)
Werkingsduur bij max intensiteit, accu BL1850B	26 u.	83 u.	33 u.	45 u.	26 u.	15 u.	75 h	21 u.	23 u.	6,5 u (flood)
Specifieke functionaliteiten	Batterijhouder met riembevestiging	Met handriem	Hoofdlamp	Reflector in 12 posities kantelbaar	Zoom functie	Reflector draaibaar en kantelbaar	Reflector draaibaar en kantelbaar	Lantaarn (360°) en zaklamp (gericht)	Lantaarn (360°) en zaklamp (gericht) USB uitgang	Modi: spot, flood, spot + flood
Afmetingen	133 x 81 x 72 mm	151 x 81 x 61 mm	133 x 76 x 88 mm	256 x 79 x 99 mm	280 x 79 x 10 mm	380 x 79 x 116 mm	383 x 79 x 110 mm	365 x 78 x 119 mm	414 x 79 x 155 mm	313 x 119 x 115 mm
Gewicht	0,56 - 0,92 kg	0,51 - 0,83 kg	0,58 - 0,64 kg	0,26 - 0,93 kg	0,73 - 1,09 kg	0,61-0,98 kg	0,70 - 1,1 kg	0,69 - 1,1 kg	0,72 - 1,1 kg	1,2 - 1,6 kg
Prijs in €	excl. btw									
	incl. btw									

DEADML801- DEADML006G

De lichtkop is draaibaar, kantelbaar en opvouwbaar



Lichtstroom (Lumen, lm): de hoeveelheid uitgestraald licht per tijdseenheid. Het is een maat voor het vermogen van de lamp.

Verlichtingssterkte (Lux, lx): de lichtstroom per oppervlakte of dus de mate waarin een vlak verlicht wordt. De verlichtingssterkte is afhankelijk van de afstand tot de lichtbron.

Verlichtingscapaciteit: de zone waar de verlichtingssterkte minstens 70 lx is (de verlichtingssterkte die minimaal nodig is om veilig te kunnen werken).

Verlichtingscapaciteit

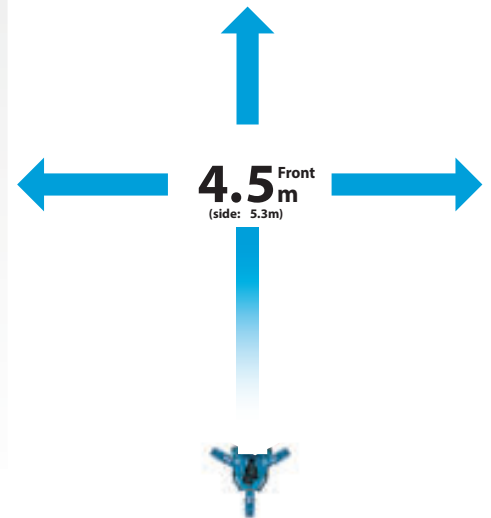

DML813



WERFLAMPEN LXT & XGT



	DEAML003G	DEAML005G	DEAML009G
Spanning	36V (40Vmax) /18V	36V (40Vmax) /18V	36V (40Vmax) /18V
Max. lichtstroom	1100 lm	3600 lm	10000 lm
Verlichtingssterkte op 1 m	500 lx	2100 lx	4300 lx
Verlichtingssterkte op 3 m	-	230 lx	500 lx
Verlichtingssterkte op 5 m	-	90 lx	110 lx
Verlichtingscapaciteit naar voor/zijdelings	2,8 m/3,0 m	6,0 m/6,4 m	9,7 m/11,4 m
Werkingsduur bij max intensiteit, accu BL4040	10 u.	3,5 u.	2,4 u.
Specifieke functionaliteiten	2 helderheidsinstellingen	3 helderheidsinstellingen	3 helderheidsinstellingen
Afmetingen	249 x 298 x 280 mm	248 x 309 x 296 mm	248 x 386 x 305 mm
Gewicht	3,7 - 4,7 kg	4,6 - 6,5 kg	6,4 - 9,9 kg
Prijs in €	excl. btw		
	incl. btw		

ACCESSOIRES



Statief voor DML805 GM00002283



Spanvijs voor DML805 GM00001396



Statief voor DML809 / DML811 / ML003G- GM00002073



ACCU BL1021B
12Vmax 2,0 Ah



197396-9
excl. btw
incl. btw

ACCU BL1041B
12Vmax 4,0 Ah



197406-2
excl. btw
incl. btw

OPLADER DC105B



197363-4
excl. btw
incl. btw

OPLADER DC18RE



LXT CXT
198720-9
excl. btw
incl. btw

Krachtig Compact Lichtgewicht

POWERPACK 12Vmax
2 x 2,0 Ah



197658-5
excl. btw
incl. btw

POWERPACK 12Vmax
2 x 4,0 Ah



197641-2
excl. btw
incl. btw

POWERPACK LXT + CXT



199026-8
excl. btw
incl. btw

POWERPACK LXT + CXT



199029-2
excl. btw
incl. btw

COMBOPACK CXT



CLX228SAX2



CLX206SAX3



CLX400SAJ1

PROMO

gratis blazer
UB101DZ bij
CLX400SAJ1



CLX228SAX2 CLX206SAX3 CLX400SAJ1

	CLX228SAX2	CLX206SAX3	CLX400SAJ1
Spanning	10,8V (12Vmax)	10,8V	10,8V
Bijgeleverde accu's	3x BL1021B	2x BL1020B	3x BL1020B
Lader	DC105B	DC105A	DC105A
Samenstelling	HP333D TD110D	TM30D DF331D	DF331D TD110D HS301D JR103D
Makpac	-	-	1
Prijs in €	excl. btw		
	incl. btw		

ACCU BOOR- EN SCHROEFMACHINES

1/4" BITOPNAME



DF032DSAJ



DF033DWAJ

DF033DWAJ DF033DWMJ DF032DSAJ DF032DSMJ

Spanning	12Vmax	10,8 V	10,8 V	10,8 V
Hard koppel	30 Nm	30 Nm	35 Nm	35 Nm
BL-motor	-	-	✓	✓
Bijgeleverde accu's	2 x BL1021B	2 x BL1040B	2 x BL1020B	2 x BL1040B
Gewicht	0,9 kg	0,9 kg	0,9 kg	0,9 kg
Prijs in €	excl. btw			
	incl. btw			

ACCU BOOR- EN SCHROEFMACHINES



DF331DSMJ



DF333DNX10

DF333DNX10

Accu boor- & schroefmachine	DF333
BL-motor	-
Bijgeleverde accu's	2 X BL1850B
Bijgeleverde accu's	1 x BL1021B
Lader	DC18RE
Prijs in €	excl. btw
	incl. btw

DF333DWAJ DF333DWMJ DF332DSAJ DF332DSMJ

Spanning	12Vmax	12Vmax	10,8 V	10,8 V
Hard koppel	30 Nm	30 Nm	35 Nm	35 Nm
BL-motor	-	-	✓	✓
Bijgeleverde accu's	2 x BL1021B	2 x BL1041B	2 x BL1020B	2 x BL1040B
Gewicht	1,1 kg	1,1 kg	1,2 kg	1,2 kg
Prijs in €	excl. btw			
	incl. btw			

ACCU KLOPBOOR- EN SCHROEFMACHINES



HP332DSMJ



HP331DWMJ

HP333DWAJ HP333DWMJ HP332DSAJ HP332DSMJ

Spanning	12Vmax	12Vmax	10,8 V	10,8 V
Hard koppel	30 Nm	30 Nm	35 Nm	35 Nm
BL-motor	-	-	✓	✓
Bijgeleverde accu's	2 x BL1021B	2 x BL1041B	2 x BL1020B	2 x BL1040B
Gewicht	1,1 kg	1,1 kg	1,1 kg	1,3 kg
Prijs in €	excl. btw			
	incl. btw			

ACCU SLAGSCHROEVENDRAAIERS



TD111DSMJ



TD110DSAJ

Assist modus voor het vlot aanzetten bij het schroeven.

	TD111DZJ	TD110DSAJ	TD111DSAJ	TD110DSMJ	TD111DSMJ
Spanning	10,8 V	10,8 V	10,8 V	10,8 V	10,8 V
Max. koppel	135 Nm	110 Nm	135 Nm	110 Nm	135 Nm
BL-motor	✓	-	✓	-	✓
Assist modus	✓	-	✓	-	✓
Bijgeleverde accu's	0	2 x BL1020B	2 x BL1020B	2 x BL1040B	2 x BL1040B
Gewicht	1,0 kg	1,0 kg	1,0 kg	1,0 kg	1,0 kg
Prijs in €	excl. btw				
	incl. btw				

SCHROEFBITSET (35 STUKS) IMPACT BLACK



Schroefbitset B-66880
35 stuks Impact Black

ACCU BOORHAMERS SDS-PLUS



HR166DSMJ



HR140DWYE1

Model HR140DWYE1 met
65-delige BORENSET

	HR140DSAJ	HR140DSMJ	HR140DWYE1	HR166DSMJ
Spanning	10,8 V	10,8 V	12Vmax	10,8 V
Slagenergie	1,0 J	1,0 J	1,0 J	1,1 J
Max. Ø beton	14 mm	14 mm	14 mm	16 mm
BL-motor	-	-	-	✓
Bijgeleverde accu's	2 x BL1020B	2 x BL1040B	2 x BL1015B	2 x BL1040B
Gewicht	1,9 kg	1,9 kg	1,9 kg	1,8 kg
Prijs in €	excl. btw			
	incl. btw			

ACCU HAAKSE BOORMACHINES

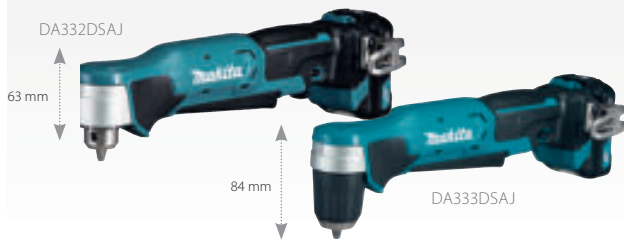

DA332DSAJ

63 mm

84 mm

DA333DSAJ

	DA332DSAJ	DA332DSMJ	DA333DSAJ	DA333DSMJ
Spanning	10,8 V	10,8 V	10,8 V	10,8 V
Boorkop	1,5-10 mm	1,5-10 mm	1,5-10 mm	1,5-10 mm
Bijgeleverde accu's	2 x BL1020B	2 x BL1040B	2 x BL1020B	2 x BL1040B
Gewicht	1,2 kg	1,2 kg	1,2 kg	1,2 kg
Prijs in €	excl. btw			
	incl. btw			

ACCU HAAKSE SLAGSCHROEVENDRAAIERS



TL064DZJ



Opname
1/4"

TL065DZJ



Opname
3/8"

	TL064DZJ	TL065DZJ
Spanning	10,8 V	10,8 V
Toerental	0-2000 t.p.m.	0-2000 t.p.m.
Bijgeleverde accu's	0	0
Gewicht	1,2 kg	1,2 kg
Prijs in €	excl. btw	
	incl. btw	

ACCU SLAGMOERSLEUTELS



TW140DSMJ



TW161DSAJ

Reverse Auto-stop:
Rotatie stopt automatisch
wanneer de bout of moer is
losgedraaid

	TW140DZJ	TW140DSAJ	TW140DSMJ	TW141DZJ	TW141DSMJ	TW160DZJ	TW160DSAJ	TW160DSMJ	TW161DZJ	TW161DSAJ	TW161DSMJ
Spanning	12Vmax	12Vmax	12Vmax	12Vmax	12Vmax	12Vmax	12Vmax	12Vmax	12Vmax	12Vmax	12Vmax
Toerental	0-2600 t.p.m.	0-2600 t.p.m.	0-2600 t.p.m.	0-2600 t.p.m.	0-2600 t.p.m.	0-1300 t.p.m. 0-2400 t.p.m.	0-1300 t.p.m. 0-2400 t.p.m.	0-1300 t.p.m. 0-2400 t.p.m.	0-1300 t.p.m. 0-2400 t.p.m.	0-1300 t.p.m. 0-2400 t.p.m.	0-1300 t.p.m. 0-2400 t.p.m.
Max. koppel	140 Nm	140 Nm	140 Nm	145 Nm	145 Nm	165 Nm	165 Nm	165 Nm	165 Nm	165 Nm	165 Nm
Snelheden	1	1	1	1	1	2	2	2	2	2	2
Auto-stop functie	-	-	-	-	-	✓	✓	✓	✓	✓	✓
Opname	3/8"	3/8"	3/8"	1/2"	1/2"	3/8"	3/8"	3/8"	1/2"	1/2"	1/2"
BL-motor	-	-	-	-	-	✓	✓	✓	✓	✓	✓
Bijgeleverde accu's	0	2 x BL1021B	2 x BL1041B	0	2 x BL1041B	0	2 x BL1021B	2 x BL1041B	0	2 x BL1021B	2 x BL1041B
Gewicht	1,0 kg	1,0 kg	1,0 kg	1,1 kg	1,1 kg	1,0 kg	1,0 kg	1,0 kg	1,1 kg	1,1 kg	1,1 kg
Prijs in €	excl. btw										
	incl. btw										

ACCU RATELMOERSLEUTEL



Geleverd met 1/4" & 3/8" opname

Verwijderbare kop laat toe om 13 mm moeren over de lengte van een M8 draadstang te schroeven.



WR100DZ

Spanning	10,8 V
Toerental onbelast	800 t.p.m.
Max. koppel	47,5 Nm
Bijgeleverde accu's	-
Gewicht	1,0 kg
Prijs in €	excl. btw
	incl. btw

ACCU NIETMACHINE



ST113DSAJ

Met repeteerfunctie en anti-droogschietmechanisme

	ST113DZJ	ST113DSAJ	ST113DSMJ
Spanning	10,8V	10,8V	10,8V
Rugbreedte niet	10 mm	10 mm	10 mm
Ladercapaciteit	150 stuks	150 stuks	150 stuks
Bijgeleverde accu's	-	2 x BL1020B	2 x BL1040B
Gewicht	1,3 kg	1,3 kg	1,5 kg
Prijs in €	excl. btw		
	incl. btw		

ACCU PINTACKER



PT354DZJ

	PT354DZJ
Spanning	10,8 V
Draadkaliber	23 Ga
Doorsnede nagel	0,6 mm
Lengte nagel	15-35 mm
Bijgeleverde accu's	-
Gewicht	2,0 kg
Prijs in €	excl. btw
	incl. btw

LUCHTPOMP



MP100DZ

Spanning	10,8V
Debiet	10 l/min (bij 2 bar)
Max. druk	8,3 bar
Bijgeleverde accu's	-
Gewicht	1,2 kg
Prijs in €	excl. btw
	incl. btw

ACCU SCHUURPOLIJSTMACHINE 75 MM



- Geleverd met adapter voor Roloc™ voor schuurtoepassingen en een velcro steunschijf voor het polijsten
- Ideaal voor oppervlaktebehandeling en voor het polijsten van kleine oppervlakken



	PV301DZJ	PV301DSAEJ
Spanning	10,8 V	10,8 V
Capaciteit polijsten	80 mm	80 mm
Capaciteit schuren	50 mm	50 mm
Toerental polijsten	0-2800 min ⁻¹	0-2800 min ⁻¹
Toerental schuren	0-9500 min ⁻¹	0-9500 min ⁻¹
Bijgeleverde accu's	-	2x BL1021B
Gewicht	1,1 kg	1,1 kg
Prijs in €	excl. btw	
	incl. btw	

ACCU CIRKELZAAG 85 MM



HS301DSAJ

		HS301DSAJ	HS301DSMJ
Spanning		10,8 V	10,8 V
Max. zaagdiepte bij (90°)		25,5 mm	25,5 mm
Bijgeleverde accu's		2 x BL1020B	2 x BL1040B
Ø Zaagblad		85 mm	85 mm
Gewicht		1,6 kg	1,6 kg
Prijs in €	excl. btw		
	incl. btw		

ACCU TEGELSNIJDER 85 MM



CC301DSMJ



		CC301DZJ	CC301DSMJ
Spanning		10,8 V	10,8 V
Zaagdiepte (90°)		25,5 mm	25,5 mm
Ø Zaagblad		85 mm	85 mm
Bijgeleverde accu's		-	2 x BL1040B
Gewicht		1,9 kg	1,9 kg
Prijs in €	excl. btw		
	incl. btw		

ACCU DRAADSTANGKNIPPER



Voor gebruiksklaar afkorten zonder vonken!

SC103DZJ

Spanning		10,8 V
Afkorten		Mobiel
Snijscapaciteit		M6 - M8 - M10
Inbegrepen mes		M8, M10
Bijgeleverde accu's		-
Gewicht		2,7 kg
Prijs in €	excl. btw	
	incl. btw	

ACCU MULTICUTTER



CP100DZJ

Spanning		10,8 V
Snijscapaciteit		6 mm
Bijgeleverde accu's		-
Gewicht		0,72 kg
Prijs in €	excl. btw	
	incl. btw	

ACCU GIPSZAAG



SD100DZJ

Spanning		10,8 V
Slaglengte		6 mm
Snijscapaciteit		30 mm
Bijgeleverde accu's		-
Gewicht		1,5 kg
Prijs in €	excl. btw	
	incl. btw	

ACCU DECOUPEERZAGEN

10.8v CXT



JV102DSAJ



JV103DSAJ

	JV101DSAJ	JV102DZJ	JV102DSAJ	JV102DSMJ	JV103DZJ	JV103DSAJ	JV103DSMJ
Spanning	10,8V	10,8V	10,8V	10,8V	10,8V	10,8V	10,8V
Aantal zaagbewegingen	0-2900 /min	800-3000 /min	800-3000 /min	800-3000 /min	800-3000 /min	800-3000 /min	800-3000 /min
Max. capaciteit hout	65 mm	90 mm	90 mm	90 mm	90 mm	90 mm	90 mm
BL-motor	-	✓	✓	✓	✓	✓	✓
Bijgeleverde accu's	2 x BL1020B	0	2 x BL1020B	2 x BL1040B	0	2 x BL1020B	2 x BL1040B
Gewicht	1,8 kg	1,8 kg	1,8 kg	1,8 kg	1,8 kg	1,8 kg	1,8 kg
Prijs in €	excl. btw						
	incl. btw						

ACCU RECIPROZAAG

10.8v CXT

MAX FAC



JR103DSAJ

	JR103DSAJ	JR103DSMJ
Spanning	10,8V	10,8V
Max. zaagcapaciteit hout/stalen buis	50 mm	50 mm
Bijgeleverde accu's	2 x BL1020B	2 x BL1040B
Gewicht	1,3 kg	1,5 kg
Prijs in €	excl. btw	
	incl. btw	

ACCU MULTITOOl

10.8v CXT

MAX FAC



TM30DSAJX3

Spanning	10,8V
Oscillatiehoek	3,2°
Oscillatiefrequentie	6000-20000 min ⁻¹
Opname	OIS, Starlock
Bijgeleverde accu's	2 x BL1020B
Gewicht	1,1 kg
Prijs in €	excl. btw
	incl. btw

ACCU KITPISTOOL

CXT 10.8v

MAX FAC



CG100DSAEA

CG100DSAEB

CG100DSAEB met aluminium kokerhouder 600 ml (voor worsten of kit in bulkverpakking)

	CG100DSAEA	CG100DSAEB
Spanning	10,8V	10,8V
Max. extrusiekracht	5000 N	5000 N
Max. extrusiesnelheid	0-28 mm/s	0-28 mm/s
Bijgeleverde accu's	2 x BL1020B	2 x BL1020B
Prijs in €	excl. btw	
	incl. btw	

STEELOFZUIGERS MET GEÏNTEGREERDE ACCU



	CL114FDWIX	CL117FDX2	CL117FDX5	CL117FDX8
Spanning	10,8 V	10,8 V	10,8 V	10,8 V
Max. debiet	1,4 m³/min	1,0 m³/min	1,0 m³/min	1,0 m³/min
Max. onderdruk	34 mbar	50 mbar	50 mbar	50 mbar
Stofopvang	Stofzak	Capsule	Capsule	Capsule
Klikvergrendeling	✓	✓	✓	✓
Bijgeleverde accu's	Geïntegreerd	Geïntegreerd	Geïntegreerd	Geïntegreerd
Kleur	Beige	Turquoise	Groen	Purper
Promo	-	-	-	-
Gewicht	0,94 kg	1,0 kg	1,0 kg	1,0 kg
Prijs in €	excl. btw			
	incl. btw			

CYCLONMODULE

- ✓ Het grove stof wordt van het fijne stof gescheiden.
- ✓ Stofzak of capsule tot 80 % minder vaak ledigen!

Cyclonmodule

De cyclonmodule wordt in lijn met de stofzuiger geplaatst. De centrifugale werking zorgt ervoor dat tot 80 % van het stof in de capsule opgevangen wordt vooraleer het de stofzuiger bereikt. Daardoor verhoogt de totale opvangcapaciteit en blijft de maximale zuigkracht van de machine langer behouden. Het reservoir van de module is zeer gemakkelijk te ledigen en uit te wassen.

Gemakkelijk te ledigen



Extra opvangcapaciteit **400 ml**



OPTIONELE ACCESSOIRES

- Muurbevestiging 199971-7
- Vloerzuigmond tapijt 198527-3
- Kierzuigmond lang 198990-0
- Ronde borstel 191D73-9 excl. ind

Ref.	Kleur	Prijs excl. btw	Prijs incl. btw
Cyclonmodule met klikvergrendeling			
191D71-3	wit		
191D73-9	zwart		
Cyclonmodule zonder klikvergrendeling			
199491-1	wit		
191d75-5	zwart		

STEELOFZUIGERS CXT/ LXT



PROMO:

- DCL182Z: gratis cyclon 199491-1 + muurbevestiging
- DCL280FZ: gratis cyclon 191D71-3 + muurbevestiging
- DCL280FZW: gratis cyclon 191D71-3 + muurbevestiging

DCL284, DCL285 & DCL286:

- Nieuwe brushless motor levert hoge zuigkracht.
- Laag geluidsniveau door vernieuwd ontwerp van luchtuitlaat.
- De DCL286 heeft een ingebouwde cyclonmodule: deze vangt grove stofdeeltjes op waardoor de optimale zuigkracht langer behouden blijft.



	CL102DW	CL107FDZW	DCL180ZB	DCL182Z	DCL280FZ	DCL280FZW	DCL282FZ	DCL284FZB	DCL284FRFB	DCL285FZ	DCL285FRF	DCL286FZW	DCL286FRFW
Spanning	10,8 V	10,8 V (CXT)	18 V (LXT)	18 V (LXT)	18 V (LXT)	18 V (LXT)	18 V (LXT)	18 V (LXT)	18 V (LXT)	18 V (LXT)	18 V (LXT)	18 V (LXT)	18 V (LXT)
Max. debiet	0,9 m³/min	1,4 m³/min	1,4 m³/min	1,4 m³/min	1,5 m³/min	1,5 m³/min	1,5 m³/min	1,2 m³/min	1,2 m³/min	1,2 m³/min	1,2 m³/min	1,0 m³/min	1,0 m³/min
Max. onderdruk	23 mbar	50 mbar	42 mbar	54 mbar	60 mbar	60 mbar	82 mbar	180 mbar	180 mbar	180 mbar	180 mbar	180 mbar	180 mbar
Stofopvang	Stofzak	Stofzak	Capsule	Stofzak	Capsule	Capsule	Stofzak	Capsule	Capsule	Stofzak	Capsule	Cycloon	Cycloon
Klikvergrendeling	-	-	-	-	✓	✓	✓	✓	✓	✓	✓	✓	✓
BL motor	-	-	-	-	✓	✓	✓	✓	✓	✓	✓	✓	✓
Bijgeleverde accu's	1 x BL1013	-	-	-	-	-	-	-	1x BL1830	-	1x BL1830	-	1x BL1830
Kleur	Wit	wit	Zwart	Blauw	Blauw	Wit	Blauw	zwart/turquoise	zwart/turquoise	Blauw	Blauw	Wit	Wit
Gewicht	1,1 kg	1,1 - 1,3 kg	1,2 kg	1,3 kg	1,2 - 1,6 kg	1,2 - 1,6 kg	1,3 - 1,6 kg	1,3 - 1,6 kg	1,3 - 1,6 kg	1,4 - 1,7 kg	1,4 - 1,7 kg	1,6 - 1,9 kg	1,6 - 1,9 kg
Prijs in €	excl. btw												
	incl. btw												

XGT STEELSTOFZUIGERS



CL003G

- Met geïntegreerde bovenaan geplaatste cycloonmodule
- De cycloonmodule vangt tot 80 % van het grove stof op, zodat de fijnfilter minder vaak gereinigd moet worden en de optimale zuigkracht langer behouden blijft.
- Stiller dankzij een hertekend design en gebruik van geluidsabsorberend materiaal.



	CL001GZ05	CL001GD208	CL002GZ03	CL002GD205	CL002GZ07	CL002GD212	CL003GZ04	CL003GD202
Spanning	40Vmax	40Vmax	40Vmax	40Vmax	40Vmax	40Vmax	40Vmax	40Vmax
Bijgeleverde accu's	-	2x BL4025	-	2x BL4025	-	2x BL4025	-	2x BL4025
Bijgeleverde lader	-	DC40RA	-	DC40RA	-	DC40RA	-	DC40RA
Max. debiet	1,2 m³/min	1,2 m³/min	1,2 m³/min	1,2 m³/min	1,2 m³/min	1,2 m³/min	1,0 m³/min	1,0 m³/min
Max. onderdruk	210 mbar	210 mbar	210 mbar	210 mbar	210 mbar	210 mbar	200 mbar	200 mbar
Stofopvang	Capsule	Capsule	Stofzak	Stofzak	Stofzak	Stofzak	Cycloon-capsule	Cycloon-capsule
Klikvergrendeling	✓	✓	✓	✓	✓	✓	✓	✓
Kleur	Turquoise	Turquoise	Zwart	Zwart	Wit	Wit	Zwart	Zwart
Gewicht	1,7 - 2,3 kg	1,7 - 2,3 kg	1,7 - 2,3 kg	1,7 - 2,3 kg	1,7 - 2,3 kg	1,7 - 2,3 kg	1,9 - 2,5 kg	1,9 - 2,5 kg
Prijs in €	excl. btw							
	incl. btw							

CLEANING COMBOPACK



CLX245SAX1

Spanning	10,8 V
Stofstofzuiger	CL108FDZW
Blaas-/ zuigmachine	UB100DZ
Meegeleverde accu's	1 x BL1021B
Lader	DC10SB
Gereedschapstas	✓
Prijs in €	excl. btw
	incl. btw

ACCU CYCLOONSTOFZUIGER



DCL501Z

Spanning	18 V
Max. debiet	1,3 m³/min
Max. onderdruk	66 mbar
Bijgeleverde accu's	0
Gewicht	3,1 kg
Prijs in €	excl. btw
	incl. btw

Technologie



Auto-start wireless system

Geniet van stofvrij werken met AWS!

Bij het starten van de accu-machine wordt de stofzuiging automatisch geactiveerd d.m.v. een Bluetooth verbinding. Wanneer het verbonden toestel uitgeschakeld wordt, gaat de stofzuiger weer in stand-by modus. Sommige accustofzuigers zoals VC009 of DVC867 hebben AWS reeds standaard ingebouwd en kunnen dus rechtstreeks communiceren met AWS-compatibele gereedschappen.

Via de optionele adapter WUT02U kunnen nu ook stofzuigers op netstroom draadloos aangestuurd worden, ongeacht het merk. De enige vereiste is dat de stofzuiger met een startautomatiek uitgerust is.

AWS-compatibele stofzuiger



DVC867L

Stofzuiger met startautomatiek



Adapter WUT02U 199773-1
excl
incl



Bluetooth unit 198900-7
excl
incl

ACCU BLAAS- EN ZUIGMACHINE



UB101DZ & DUB186:
uitvoering met lange pijp,
ideaal om laag bij de grond
te blazen.



DUB186Z

DUB185Z

	UB100DZ	UB101DZ	DUB185Z	DUB186Z
Spanning	10,8V	10,8V	18V	18V
Max. luchtsnelheid	75 m/s	65 m/s	98 m/s	68 m/s
Max. debiet	2,6 m³/min	2,6 m³/min	3,2 m³/min	3,2 m³/min
Gewicht	1,4 kg	1,4 kg	1,6 kg	1,6 kg
Prijs in €	excl. btw			
	incl. btw			

BLAAS- EN ZUIGMACHINE



Multifunctionele schakelaar
met snelheidsinstelling

UB1103

Vermogen	600 W
Max. luchtsnelheid	91 m/s
Max. debiet	4,1 m³/min
Gewicht	2,0 kg
Prijs in €	excl. btw
	incl. btw

ACCU RUGGEDRAGEN STOFZUIGERS



DVC660

DVC665



DVC660
Uitvoering speciaal voor schoonmaak, geleverd met diverse accessoires.

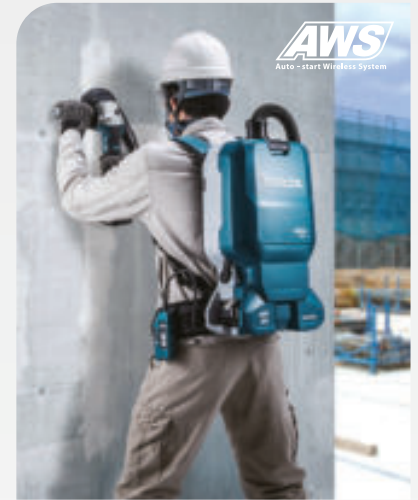

DVC665
Uitvoering voor stofafzuiging in combinatie met machines.



HEPA-filter

Als hoofdfilter wordt een HEPA-filter gebruikt die zeer fijne stofdeeltjes effectief tegenhoudt. De filter kan tot 99,97 % van de deeltjes tussen 0,3 en 1 µm filteren, waardoor de uitgeblazen lucht zeer zuiver is.



Filterreiniging

Door de trillingen van het stappen of het manueel indrukken van de hendel wordt het fijn stof van de papierfilter geschud. Daardoor blijft de zuigkracht langer optimaal bij het opzuigen van fijn stof.



DVC265ZXU DVC261ZX11 DVC660Z DVC665ZX1U

Spanning	2 x 18V	2 x 18V	2 x 18V	2 x 18V
Max. debiet	1,8-2,2 m³/min	1,8-2,2 m³/min	1,8-2,2 m³/min	1,8-2,2 m³/min
Max. onderdruk	110 mbar	110 mbar	110 mbar	110 mbar
Uitvoering	Stofafzuiging machines	Schoonmaak	Schoonmaak	Stofafzuiging machines
Capaciteit stofzak	2l	2l	6l	6l
AWS	✓	-	-	✓
Gewicht	3,9 kg	3,8 kg	6,1 kg	6,1 kg
Prijs in €	excl. btw			
	incl. btw			

ACCU RUGGEDRAGEN STOFZUIGERS



VC008GZ



VC009GZ
(Geleverd zonder batterijen en zonder oplader)

- Hogere zuigkracht dankzij de 40Vmax accutechnologie
- Geluidsarm door een hertekend design van de luchtuitlaat en gebruik van geluidsabsorberend materiaal.
- VC008GZ wordt standaard geleverd met accessoires voor schoonmaaktoepassingen.
- VC009GZ01 wordt geleverd met twee zuigslangen en hulpstukken voor stofafzuiging in combinatie met machines.

VC008GZ VC009GZ01

Spanning	40Vmax	40Vmax
Max. debiet	2,4 m³/min	1,9 m³/min
Max. onderdruk	180 mbar	180 mbar
Uitvoering	Schoonmaak	Stofafzuiging machines
Capaciteit stofzak	2,0l	2,0l
AWS	-	✓
Gewicht	4,1 - 5,3 kg	4,1 - 5,3 kg
Prijs in €	excl. btw	
	incl. btw	

ACCU RECHTOPSTAANDE STOFZUIGER

18V + 18V → 36V

Met roterende borstel, ideaal voor tapijt
 Aparte motor voor het aandrijven van de borstel
 Telescopische aluminium steel



Met aparte aluminium buis om moeilijk bereikbare plaatsen te reinigen



Zeer wendbaar, geen voedingskabel en geen zuigslang!

3 vermogenstanden



Instelbare hoogte van de borstel (4 hoogtes, max 10 mm)



DVC560Z

Spanning	2 x 18V	
Max. debiet	1,9 m³/min	
Max. onderdruk	120 mbar	
Bijgeleverde accu's	0	
Gewicht	8,3 kg	
Prijs in €	excl. btw	
	incl. btw	

ACCU COMPACTE STOFZUIGER

LXT 18V LITHIUM-ION



Inclusief draagriem, vloerzuigmond & kierzuigmond

DVC750LZX1

Spanning	18V	
Max. debiet	1,4 m³/min	
Max. onderdruk	64 mbar	
Bijgeleverde accu's	0	
Gewicht	4,2 kg	
Prijs in €	excl. btw	
	incl. btw	

ACCU COMPACTE STOFZUIGER

12V max LITHIUM-ION

18V LITHIUM-ION

IDEAAL VOOR DE AUTO



DCL184Z

Met blaasfunctie

Inclusief accessoires

CL121DZJ DCL184Z

Spanning	10,8V	18V
Max. debiet	1,3 m³/min	1,3 m³/min
Max. onderdruk	44 mbar	47 mbar
Bijgeleverde accu's	-	-
Lader	-	-
Gewicht	1,7	2,1 kg
Prijs in €	excl. btw	
	incl. btw	

Zuigmond voor matten



Zuigmond voor zetels



Rubberen zuigmond



Zachte borstel



Blaasmond



DRC200

- Verschillende sensoren voor obstakel- en grensdetectie
- Patroonmodus voor grote vloeroppervlakken met weinig obstakels, zoals een magazijn of een lange gang
- Willekeurige modus voor vloeroppervlakken met veel obstakels, zoals in een kantoor.
- Door middel van grenstape kan de gebruiker de zone afbakenen waarbinnen de robot mag werken.
- Modi "alleen borstelen" of "stofzuigen + borstelen"
- Bediening op het toestel zelf of met bijgeleverde afstandsbediening
- Werkt op één 18 V accu of twee in parallel. De accu's moeten uit het toestel verwijderd worden om op te laden.



**OPPERVLAKTE
TOT 500 m²**

Patroonmodus

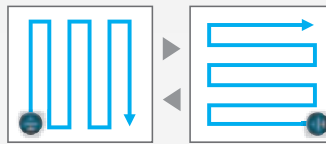

Willekeurige modus

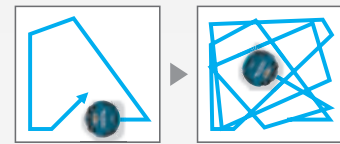

**OPPERVLAKTE
TOT 600 m²**



DRC300Z



De camera maakt beelden van het plafond ter ondersteuning van de navigatie



DRC300

- Kan ruimtes in kaart brengen door gebruik te maken van LiDAR module en beeldcamera. Tot 5 ruimtes kunnen in het geheugen bewaard worden. Dankzij de intelligente positiebepaling kan een ruimte efficiënter gereinigd worden en kan de machine ook automatisch terugkeren naar het beginpunt
- Verschillende sensoren voor obstakel- en grensdetectie
- Modi "alleen borstelen" of "stofzuigen + borstelen"
- Bediening op het toestel zelf, met de afstandsbediening of met de smartphone app (Wifi verbinding)
- Via de smartphone app kunnen de bewaarde kaarten weergegeven en geoptimaliseerd worden (bv. het definiëren van verboden zones) en kan ook schoonmaakstatus en -historiek gecontroleerd worden
- Werkt op één 18 V accu of twee in parallel. De accu's moeten uit het toestel verwijderd worden om op te laden.

DRC200Z DRC200PTJ DRC300Z

Spanning	18 V (één of 2 in parallel)		
Bijgeleverde accu's	-	2 x BL1850B	-
Lader	-	DC18RD	-
Capaciteit opvangbak	2,5 l	2,5 l	3,0 l
Max. registreerbare oppervlakte	-	-	10000 m ²
Max. snelheid	0,3 m/s	0,3 m/s	0,3 m/s
Navigatie	Willekeurig of vast patroon	Willekeurig of vast patroon	Intelligent op basis van kaart
LiDAR sensor	-	-	✓
Camera	-	-	✓
Configuratie en besturing met app	-	-	✓
Afbakenen van verboden zones	Tape	Tape	Tape of via app
Terugkeren naar beginpunt	-	-	✓
Gewicht	6,8 - 7,8 kg	6,8 - 7,8 kg	9,6 - 10,6 kg
Prijs in €	excl. btw		
	incl. btw		

ACCU STOFZUIGERS L-KLASSE LXT



DVC155LZX2



DVC863LZ



DVC867LZX4



DVC157LZX3

Promo: gratis CL102DW bij DVC863LZ



	DVC150LZ	DVC155LZX2	DVC863LZ	DVC153LZ	DVC867LZX4	DVC157LZX3
Spanning	2 x 18 V / 230 V	2 x 18 V	2 x 18 V	2 x 18 V	2 x 18 V	2 x 18 V
Bijgeleverde accu	-	-	-	-	-	-
Kuipvolume	15 l	15 l	8 l	15 l	8 l	15 l
Type	Nat & Droog	Nat & Droog	Droog	Droog	Droog	Droog
Filter	Textielfilter	Textielfilter	HEPA	HEPA	HEPA	HEPA
Max. debiet	2,1 / 3,6 m ³ /min	2,1 m ³ /min	2,1 m ³ /min	2,1 m ³ /min	2,4 m ³ /min	2,4 m ³ /min
Max. onderdruk	90 / 240 mbar	110 mbar	98 mbar	98 mbar	110 mbar	110 mbar
AWS	-	-	-	-	✓	✓
Gewicht	8,9 kg	7,9 kg	7,9 kg	7,9 kg	7,8 kg	8,0 kg
Prijs in €	excl. btw					
	incl. btw					

ACCU STOFZUIGERS L-KLASSE XGT



VC003GLZ

VC004GLZ

VC005GLZ



- Voeding met twee 40Vmax accu's in parallel.
- Hoge zuigkracht dankzij hoger vermogen en verbeterde koeling.
- Met telescopische steel (VC001G/VC003G/VC005G)
- Vloerborstel met laag profiel en verstelling voor harde vloer of tapijt (VC001G/VC003G/VC005G).
- VC005G: hoge wendbaarheid en stabiliteit door extra grote wielen achteraan.

Toepassing:

- VC001G / VC003G: voor algemeen droog en nat gebruik (schoonmaak).
- VC002G/VC004G: ideaal voor stofafzuiging van machines (met HEPA filter en AWS).
- VC005G: voor algemeen droog gebruik (schoonmaak).

	VC001GLZ	VC003GLZ	VC002GLZ01	VC004GLZ01	VC005GLZ
Spanning	36 V (40Vmax)	36 V (40Vmax)	36 V (40Vmax)	36 V (40Vmax)	36 V (40Vmax)
Bijgeleverde accu's	-	-	-	-	-
Type	Droog/Nat	Droog/Nat	Droog	Droog	Droog
Capaciteit	8 l	15 l	8 l	15 l	8 l
Max. debiet	3,2 m ³ /min	3,2 m ³ /min	1,8 m ³ /min	1,8 m ³ /min	2,8 m ³ /min
Max. onderdruk	230 mbar	230 mbar	230 mbar	230 mbar	230 mbar
Filter	Textielfilter	Textielfilter	HEPA	HEPA	Textielfilter
AWS	-	-	✓	✓	-
Gewicht	8,1 - 10 kg	8,1 - 10 kg	8,3 - 10,2 kg	8,3 - 10,2 kg	7,9 - 9,8 kg
Prijs in €	excl. btw				
	incl. btw				

Gewicht en slagenergie zijn conform met EPTA-procedures.

WAT BETEKEN L-, M- OF H-KLASSE?

Stofzuigers voor professioneel gebruik worden volgens EN60335-2-69 ingedeeld in risicoklassen:

L-klasse (Low risk) stofzuigers mogen gebruikt worden voor alle stof waarvan de toelaatbare blootstellingswaarde groter is dan 1 mg/m^3 . Deze stofzuigers laten minder dan 1 % van het opgezogen stof door.

M-klasse (Medium risk) stofzuigers mogen gebruikt worden voor alle stof waarvan de toelaatbare blootstellingswaarde groter is dan $0,1 \text{ mg/m}^3$. Deze stofzuigers laten minder dan 0,1 % van het opgezogen stof door en voldoen bovendien aan een aantal bijkomende eisen, waaronder permanente debietcontrole en stofarme lediging.

H-klasse stofzuigers (High risk) moeten gebruikt worden voor stoffen waarvan de max. blootstellingswaarde $< 0,1 \text{ mg/m}^3$ bedraagt. Deze stofzuigers laten minder dan 0,005 % van het opgezogen stof door en moeten ook voldoen aan een aantal bijkomende eisen, zoals permanente debietcontrole en stofarme lediging.

Opgelet: stofzuigers zonder aanduiding van de stofklasse volgens EN60335-2-69 bieden geen enkele garantie op het vlak van persoonlijke veiligheid en zijn derhalve niet geschikt voor professioneel gebruik.

ACCU STOFZUIGERS L-KLASSE XGT

- Accu stofzuigers met hoge zuigkracht, vergelijkbaar met AC-modellen
- Stofklasse L, met HEPA-filter
- Nat en droog gebruik, uitgerust met waterniveausensor en waterafvoer
- Automatisch zelfreinigende filter met dubbel filtersysteem
- Inclusief slang 28 mm en 38 mm, gebogen buis en vloerzuigmond
- AWS: de stofzuiger kan automatisch aangestuurd worden door AWS-compatibele power tools

NIEUW
VC007GLZ01

Spanning	72 V (80Vmax)
Bijgeleverde accu's	-
Lader	-
Kuipvolume	40 l
Type	nat/droog
Filterklasse	L (HEPA)
Max. debiet (38 mm slang)	3,7 m ³ /min
Max. debiet (28 mm slang)	2,0 m ³ /min
Max. onderdruk	180 mbar
Gewicht	18,3 - 20,7 kg
Prijs in €	excl. btw
	incl. btw

ACCU STOFZUIGERS M-KLASSE XGT

VC007GL, VC006GM: dubbel filtersysteem met automatisch zelfreinigende filter, zonder zuigkrachtonderbreking



De VG006GM heeft een instelling van de slangdiameter en waarschuwingszoemer voor te lage luchtstroom.



- Accu stofzuigers met hoge zuigkracht, vergelijkbaar met AC-modellen
- Stofklasse M
- Nat en droog gebruik, uitgerust met waterniveausensor en waterafvoer
- Automatisch zelfreinigende filter met dubbel filtersysteem
- Inclusief slang 28 mm en 38 mm, gebogen buis en vloerzuigmond
- AWS: de stofzuiger kan automatisch aangestuurd worden door AWS-compatibele power tools

NIEUW
VC006GMZ01

Spanning	72 V (80Vmax)
Bijgeleverde accu's	-
Lader	-
Kuipvolume	40 l
Type	nat/droog
Filterklasse	M
Max. debiet (38 mm slang)	3,7 m ³ /min
Max. debiet (28 mm slang)	2,0 m ³ /min
Max. onderdruk	180 mbar
Gewicht	18,4 - 20,8 kg
Prijs in €	excl. btw
	incl. btw

STOFZUIGERS L-KLASSE

INCLUSIEF
1 SET ACCESSOIRES



STOFZUIGERS L-, M- EN H-KLASSE

INCLUSIEF
1 SET ACCESSOIRES



Automatische filterreiniging
zonder zuigkracht-
onderbreking.

Automatische filterreiniging
zonder zuigkracht-
onderbreking.

STOFZUIGERS L- EN M-KLASSE

INCLUSIEF
1 SET ACCESSOIRES



Automatische filterreiniging
zonder zuigkrachtonderbreking.

Automatische filterreiniging
zonder zuigkrachtonderbreking.

Automatische filterreiniging
zonder zuigkrachtonderbreking.



	VC2000L	VC2012L	VC2512L	VC3011L	VC3012L	VC3012M	VC2211MX1
Nominaal vermogen	1000 W	1100 W	1100 W	1000 W	1200 W	1200 W	1050 W
Max. debiet	3,6 m³/min	3,6 m³/min	3,6 m³/min	3,6 m³/min	3,7 m³/min	3,7 m³/min	3,5 m³/min
Max. onderdruk	210 mbar	210 mbar	210 mbar	210 mbar	230 mbar	230 mbar	220 mbar
Bruto kuipvolume	20 l	19 l	23 l	30 l	30 l	30 l	22 l
Gewicht	7,5 kg	7,3 kg	6,3 kg	10,5 kg	10 kg	10 kg	16,3 kg
Prijs in €	excl. btw						
	incl. btw						

	VC2510LX1	VC3210LX1	VC3211MX1	VC3211HX1	VC4210LX	VC4210MX
Nominaal vermogen	1050 W	1050 W	1050 W	1050 W	1200 W	1200 W
Max. debiet	3,5 m³/min	3,5 m³/min	3,5 m³/min	3,5 m³/min	4,5 m³/min	4,5 m³/min
Max. onderdruk	220 mbar	220 mbar	220 mbar	220 mbar	250 mbar	250 mbar
Bruto kuipvolume	32 l	40 l	40 l	40 l	42 l	42 l
Gewicht	10,5 kg	14,5 kg	16,9 kg	16,9 kg	15 kg	15 kg
Prijs in €	excl. btw					
	incl. btw					

BOORHAMERS SDS-PLUS 2 FUNCTIES



HR1841FJ

HR2800



	HR2600	HR1841FJ	HR2800
Nominaal vermogen	800 W	470 W	800 W
Slagenergie	2,4 J	1,4 J	2,8 J
Max. Ø beton	26 mm	18 mm	28 mm
AVT	-	✓	-
Vibratieniveau hamerboren	15,5 m/s ²	7,5 m/s ²	20 m/s ²
Gewicht	2,8 kg	2,5 kg	3,4 kg
Prijs in €	excl. btw		
	incl. btw		

COMBIHAMERS SDS-PLUS 3 FUNCTIES



HR2630X7

Inclusief automatische boorkop bij HR2630X7

Inclusief Boor- en beitelset 17 stuks bij HR2630TX12 & HR2631FT12 t.w.v.



HR2631FT12



HR2470

	HR2470	HR2630X7	HR2630TX12	HR2631FT12	HR2811FT
Nominaal vermogen	780 W	800 W	800 W	800 W	800 W
Slagenergie	2,4 J	2,4 J	2,4 J	2,4 J	2,9 J
Max. Ø beton	24 mm	26 mm	26 mm	26 mm	28 mm
AVT	-	-	-	✓	-
Vibratieniveau hamerboren	15,5 m/s ²	15 m/s ²	15 m/s ²	11,5 m/s ²	15 m/s ²
Gewicht	3,0 kg	3,0 kg	2,9 kg	3,0 kg	3,6 kg
Prijs in €	excl. btw				
	incl. btw				

COMBIHAMERS SDS-PLUS MET STOFAFZUIGING



Inclusief boor- en beitelset 17 stuks bij HR2651TX12 t.w.v.



Inclusief stofafzuigingsunit DX11 bij HR3012FCWJ



HR2651TX12

HR3012FCWJ

	HR2651TX12	HR3012FCWJ
Nominaal vermogen	800 W	1050 W
Slagenergie	2,2 J	3,9 J
Max. Ø beton	26 mm	30 mm
AVT	✓	✓
Vibratieniveau hamerboren	11,5 m/s ²	9,5 m/s ²
Gewicht	4,2 kg	4,4 kg
Prijs in €	excl. btw	
	incl. btw	

COMBIHAMERS SDS-PLUS



HR3210FCT

HR3210FCT:
met anti-vibratie
handgreep

INCLUSIEF
1 automatische
boorkop (194568-7)
bij HR3210FCT



	HR3200C	HR3210FCT
Nominaal vermogen	850 W	850 W
Slagenergie	5,1 J	4,9 J
Max. Ø beton	32 mm	32 mm
AVT	-	✓
Vibratieniveau hamerboren	18 m/s ²	10 m/s ²
Gewicht	4,8 kg	5,4 kg
Prijs in €	excl. btw	
	incl. btw	

COMBIHAMERS SDS-MAX



gratis 5-delige boor- en
beitelset
P-52445 bij HR4013C, HR4511C
en HR5212C
t.w.v.



HR4013CV

CV-modellen
inclusief
stofafzuigset

	HR3541FCX	HR4013C	HR4013CV	HR4511C	HR4511CV	HR5212C	HR5212CV
Nominaal vermogen	850 W	1100 W	1100 W	1350 W	1350 W	1500 W	1500 W
Slagenergie	5,7 J	8,0 J	8,0 J	9,4 J	9,4 J	18,9 J	18,9 J
Max Ø beton	35 mm	40 mm	40 mm	45 mm	45 mm	52 mm	52 mm
AVT	✓	✓	✓	✓	✓	✓	✓
Vibratieniveau hamerboren	11 m/s ²	5,0 m/s ²	5,0 m/s ²	7,5 m/s ²	7,5 m/s ²	12,5 m/s ²	12,5 m/s ²
Gewicht	5,6 kg	6,8 kg	6,8 kg	8,8 kg	8,8 kg	12,1 kg	12,1 kg
Prijs in €	excl. btw						
	incl. btw						

STOFAFZUIGSET VOOR BOOR-EN BREEKHAMERS



		199142-6	195866-2	196858-4
		HR4013C	HR4511C	HR5212C
Prijs in €	excl. btw			
	incl. btw			

BIKHAMERS SDS-PLUS



HK1820

	HK0500	HK1820
Nominaal vermogen	550 W	550 W
Slagfrequentie	2000-3500 /min	0-3200 /min
Slagenergie	1,8 J	3,1 J
AVT	-	-
Triaxiale vibratiewaarde (ah)	9,5 m/s ²	10 m/s ²
Gewicht	3,2 kg	3,4 kg
Prijs in €	excl. btw	
	incl. btw	

BREEKHAMERS SDS-MAX



HM1213C



HM121C

PROMO
gratis 5-delige
beitelset
E-20236 bij
HM0871C

Wist u dat u tijdens de garantieperiode recht hebt op één gratis onderhoudsbeurt? Ontdek er meer over op www.makita.be



HM0871C

AVT
ANTI VIBRATION TECHNOLOGY
SOFT NO LOAD

CV-modellen
inclusief
stofafzuigset

	HM0870C	HM0871C	HM1101C	HM1101CV
Nominaal vermogen	1100 W	1100 W	1300 W	1300 W
Slagfrequentie	1100-2650 /min	1100-2650 /min	1100-2600 /min	1100-2600 /min
Slagenergie	7,6 J	8,1 J	11,5 J	11,5 J
AVT	-	✓	-	-
Triax. vibratie beitelen (ah)	11,5 m/s ²	8 m/s ²	13,5 m/s ²	13,5 m/s ²
Gewicht	5,1 kg	5,8 kg	7 kg	7 kg
Prijs in €	excl. btw			
	incl. btw			

	HM1111C	HM1203C	HM1213C	HM1214C
Nominaal vermogen	1300 W	1510 W	1510 W	1510 W
Slagfrequentie	1100-2600 /min	950-1900 /min	950-1900 /min	950-1900 /min
Slagenergie	11,2 J	19,1 J	18,6 J	19,9 J
AVT	✓	-	✓	✓
Triax. vibratie beitelen (ah)	8 m/s ²	15,5 m/s ²	7 m/s ²	8 m/s ²
Gewicht	7,7 kg	9,7 kg	10,8 kg	12,3 kg
Prijs in €	excl. btw			
	incl. btw			

STOFAFZUIGING BREEKHAMERS

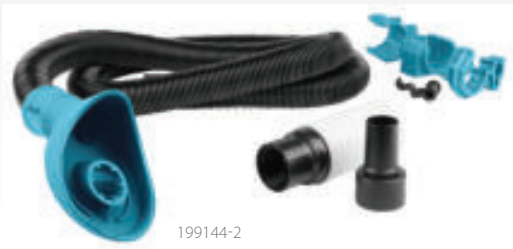

199144-2



197168-2

		199144-2	197168-2
Geschikt voor		Breekhamers SDS-Max	HM1812 / HM1317C
Prijs in €	excl. btw		
	incl. btw		

**SOFT
NO LOAD**

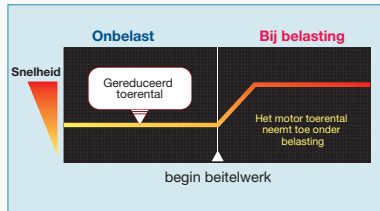

Reduceert automatisch het toerental van de machine om ongewenste trillingen verder te reduceren.

BREEKHAMERS MET ZESKANTOPNAME



**SOFT
NO LOAD** **AVT**
ANTI VIBRATION TECHNOLOGY

HM1511/HM1512:
Slagenergie
48,9 J



HM1812

HM1812:
Slagenergie 72,8 J

**GRATIS
trolley bij
HM1812**



HM1511

HM1511 / HM1512 :
Uitzonderlijk laag trillings-
niveau door anti-vibratie behuizing,
actieve trillingsdemping en de
soft-no-load regeling



	HM1317C	HM1511	HM1512	HM1812
Nominaal vermogen	1510 W	1850 W	1850 W	2000 W
Slagfrequentie	730-1450 /min	1300 /min	1300 /min	870 /min
Slagenergie	25 J	48,9 J	48,9 J	72,8 J
AVT	✓	✓	✓	✓
Triax. vibratie beitelen (ah)	8,5 m/s ²	6,5 m/s ²	6,5 m/s ²	6,5 m/s ²
Opname hex.	30 mm	30 mm	28,6 mm	28,6 mm
Gewicht	17 kg	19,2 kg	20,4 kg	31,3 kg
Prijs in €	excl. btw			
	incl. btw			

KLOPBOORMACHINES



HP2071FJ

	HP1631KSP	HP2051FHJ	HP2071FJ
Nominaal vermogen	710 W	720 W	1010 W
Toerental	0-3200 t.p.m.	0-2900 t.p.m.	0-2900 t.p.m.
Ø Max. staal	13 mm	13 mm	18 mm
Ø Max. hout	30 mm	40 mm	40 mm
Ø Max. steen	16 mm	20 mm	20 mm
Boorkop	1,5-13 mm	1,5-13 mm	1,5-13 mm
Makpac	-	✓	✓
Gewicht	2 kg	2,5 kg	2,6 kg
Prijs in €	excl. btw		
	incl. btw		

BOORMACHINES



DP4011

DP4011
Met 2 snelheden

	DP2011	DP4003	DP4011
Nominaal vermogen	370 W	750 W	720 W
Toerental	0-4200 t.p.m.	0-700 t.p.m.	0-2900 t.p.m.
Ø Max. staal	6,5 mm	13 mm	13 mm
Ø Max. hout	15 mm	38 mm	40 mm
Boorkop	0,8-6,5 mm	1,5-13 mm	1,5-13 mm
Gewicht	1,1 kg	2,4 kg	2,3 kg
Prijs in €	excl. btw		
	incl. btw		

HAAKSE BOORMACHINES



DA3010FJ

DA3011FJ



	DA3010FJ	DA3011FJ
Nominaal vermogen	450 W	450 W
Toerental	0-2400 t.p.m.	0-2400 t.p.m.
Ø Max. staal	10 mm	10 mm
Ø Max. hout	25 mm	25 mm
Boorkop	1-10 mm	1-10 mm
Gewicht	1,6 kg	1,6 kg
Prijs in €	excl. btw	
	incl. btw	

KLOPBOORMACHINE MET SLIPKOPPELING



8406

Nominaal vermogen	850 W
Toerental	0 - 1500 t.p.m.
Ø Max. staal	13 mm
Max. slagfrequentie	22500 /min
Gewicht	3,7 kg
Prijs in €	excl. btw
	incl. btw

KERNBOORMACHINE MET MAGNEETVOET



HB350 HB500

	HB350	HB500
Nominaal vermogen	1050 W	1150 W
Toerental onbelast 1	450 t.p.m.	350 t.p.m.
Toerental onbelast 2	850 t.p.m.	650 t.p.m.
Ø Max. staal	35 mm	50 mm
Klemkracht magneetvoet	8000 N	9300 N
Opname	3/4" WELDON	3/4" WELDON
Gewicht	11,5 kg	18,5 kg
Prijs in €	excl. btw	
	incl. btw	

DIAMANTKERNBOORMACHINES



DBM131W

DBM131W / DBM230W
Geleverd met boorstandaard



	DBM131	DBM131W	DBM230W
Nominaal vermogen	1700 W	1700 W	2500 W
Toerental onbelast 1	1100 t.p.m.	1100 t.p.m.	390 t.p.m.
Toerental onbelast 2	2300 t.p.m.	2300 t.p.m.	1040 t.p.m.
Toerental onbelast 3	-	-	1700 t.p.m.
Ø Max. beton	132 mm	132 mm	230 mm
Gewicht	6,1 kg	6,1 kg	6,9 kg
Prijs in €	excl. btw		
	incl. btw		

MENGRS



UT1600

	UT1400	UT1401	UT1600
Nominaal vermogen	1300 W	1300 W	1800 W
Toerental onbelast 1	0-900 t.p.m.	0-400 t.p.m.	0-440 t.p.m.
Toerental onbelast 2	-	0-730 t.p.m.	0-970 t.p.m.
Toerental belast max.	0-580 t.p.m.	0-450 t.p.m.	0-580 t.p.m.
Schroefdraad spindel	M14	M14	M14
Gewicht	5,2 kg	5,5 kg	7,1 kg
Prijs in €	excl. btw		
	incl. btw		

BOORMACHINE / MENGER



DS4012

Nominaal vermogen	750 W
Toerental	600 t.p.m.
Ø Max. staal	13 mm
Ø Max. hout	36 mm
Boorkop	2-13 mm
Gewicht	2,8 kg
Prijs in €	excl. btw
	incl. btw

SCHROEFAUTOMATEN



6843J

	6844	6843J
Nominaal vermogen	470 W	470 W
Toerental	3000 t.p.m.	6000 t.p.m.
Ø gipsplaatschroef	3,5 - 4,0 mm	3,5 - 4,0 mm
Schroeflengte	45-75 mm	25-55 mm
Verpakking	Koffer	Makpac
Gewicht	2 kg	2 kg
Prijs in €	excl. btw	
	incl. btw	

SCHROEFMACHINES VOOR GIPSPLAAT



FS2500K: met 1/4" Hex bitopname



FS2500



FS2701K

FS2701K:
met koppelinstelling
(6 stappen)



schroeflintadapter
191L24-0

	FS2300K	FS2500K	FS2701K	FS4000JX2	FS6300RJX2
Nominaal vermogen	570 W	570 W	570 W	570 W	570 W
Toerental	0-2500 t.p.m.	0-2500 t.p.m.	0-2500 t.p.m.	0-4000 t.p.m.	0-6000 t.p.m.
Ø gipsplaatschroef	5 mm	5 mm	5 mm	5 mm	5 mm
Incl. schroeflintadapter	-	-	-	✓	✓
Gewicht	1,7 kg	1,6 kg	1,7 kg	1,3 kg	1,4 kg
Prijs in €	excl. btw				
	incl. btw				

HETELUCHTPISTOLEN



HG6531CK



HG5030K

	HG5030K	HG6031VK	HG6531CK
Vermogen	1600 W	1800 W	2000 W
Temperatuurbereik	350-500 °C	50-600 °C	50-650 °C
Temperatuurstelling	2 niveaus	9 niveaus	Elektronisch in stappen van 5°C
Debiet	300 / 500 l/min	250 / 500 l/min	200 / 550 l/min
Gewicht	0,56 kg	0,67 kg	0,71 kg
Prijs in €	excl. btw		
	incl. btw		

SLAGMOERSLEUTELS



TW0350J

TW0200J
TW0350J
6906J

	TW0200J	TW0350J	6906J	TW1000
Nominaal vermogen	380 W	400 W	650 W	1300 W
Max. koppel	200 Nm	350 Nm	588 Nm	1000 Nm
Bitopname	1/2" vierkant	1/2" vierkant	3/4" vierkant	1" vierkant
Gewicht	2,2 kg	3 kg	5,6 kg	8,6 kg
Prijs in €	excl. btw			
	incl. btw			

KNABELSCHAREN



JN3201J

	JN1601	JN3201J
Nominaal vermogen	550 W	710 W
Max. dikte staal	1,6 mm	3,2 mm
Gewicht	1,6 kg	3,4 kg
Prijs in €	excl. btw	
	incl. btw	

PLAATSCHAREN



JS1602J

	JS1601J	JS1602J	JS3201J
Nominaal vermogen	380 W	380 W	710 W
Aantal zaagbewegingen	4500 /min	4000 /min	1600 /min
Max. dikte staal	1,6 mm	1,6 mm	3,2 mm
Gewicht	1,4 kg	1,6 kg	3,4 kg
Prijs in €	excl. btw		
	incl. btw		

METAALCIRKELZAAG



4131

	4131
Nominaal vermogen	1100 W
Toerental	3500 t.p.m.
Zaagdiepte (90°)	63 mm
Ø Zaagblad	185 mm
Gewicht	5,1 kg
Prijs in €	excl. btw
	incl. btw

GROEFFREES





Voor aluminium /
composiet platen

	CA5000XJ
Nominaal vermogen	1300 W
Toerental	2200-6400 t.p.m.
Ø Zaagblad	118 mm
Gewicht	5,1 kg
Prijs in €	excl. btw
	incl. btw

COMFORTABEL WERKEN MET SUPER JOINT SYSTEM II

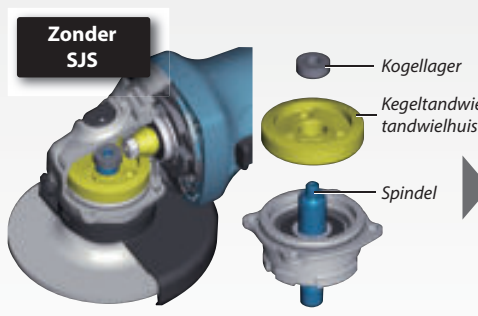
Zonder SJS





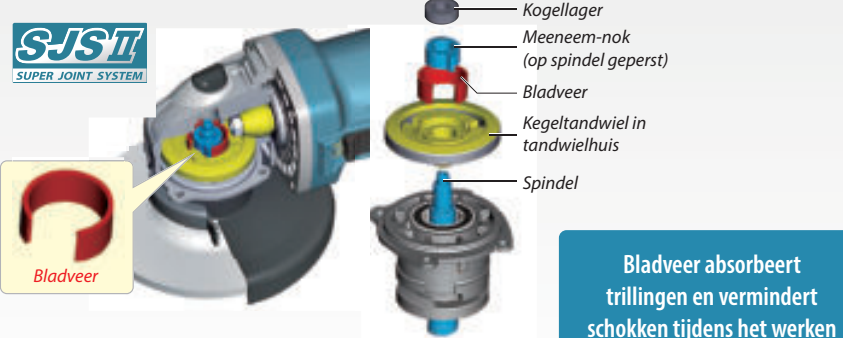

Bladveer absorbeert trillingen en vermindert schokken tijdens het werken

HAAKSE SLIJPER 125 MM



GA5034



		GA5034	GA5030RK	GA5030RSP2
Nominaal vermogen		720 W	720 W	720 W
Toerental		11000 t.p.m.	11000 t.p.m.	11000 t.p.m.
Ø schijf		125 mm	125 mm	125 mm
Dodemansschakelaar		✓	-	-
Gewicht		1,9 kg	1,8 kg	1,8 kg
Prijs in €	excl. btw			
	incl. btw			

HAAKSE SLIJPER 115 MM



GA4530RK

		GA4530RK
Nominaal vermogen		720 W
Toerental		11000 t.p.m.
Ø schijf		115 mm
Gewicht		1,8 kg
Prijs in €	excl. btw	
	incl. btw	

HAAKSE SLIJPER 125 MM

9558HNRGK3



9558HNRGK3:
geleverd met
1 afbraamschijf en
2 diamantschijven



9558PBGY met dodemansschakelaar: motor schakelt uit bij loslaten van schakelaar voor verhoogde veiligheid

		9558HNRGZ	9558PBGY	9558HNRGK3
Nominaal vermogen		840 W	840 W	840 W
Toerental		11000 t.p.m.	11000 t.p.m.	11000 t.p.m.
Ø schijf		125 mm	125 mm	125 mm
Dodemansschakelaar		-	✓	-
Gewicht		2,1 kg	2,1 kg	2,1 kg
Prijs in €	excl. btw			
	incl. btw			

HAAKSE SLIJPER 125 MM X-LOCK



Snel en veilig schijven bevestigen via een kliksysteem.



GA5080RX03

GA5080RX03

Nominaal vermogen	1400 W
Toerental	12000 t.p.m.
Ø schijf	125 mm
Verpakking	Makpac
Gewicht	2,5 - 3,6 kg
Prijs in €	excl. btw
	incl. btw

HAAKSE SLIJPERS 125 MM



GA5041CT01

GA5040CJD1



GA5041CT01 met mechanische motorrem, instelbaar toerental, Ezynut & AVT-grip

SA5040C Traagdraaiend

	GA5040RZ	GA5040RKDJ	GA5040C	GA5040CJD	GA5040CJD1	GA5041RZ	GA5041CT01	SA5040C
Nominaal vermogen	1100 W	1100 W	1400 W	1400 W	1400 W	1100 W	1400 W	1400 W
Toerental	11000 t.p.m.	11000 t.p.m.	2800-11000 t.p.m.	2800-11000 t.p.m.	2800-11000 t.p.m.	11000 t.p.m.	2700-11000 t.p.m.	2000-7800 t.p.m.
Heropstartbeveiliging	✓	✓	✓	✓	✓	✓	✓	✓
Mechanische rem	-	-	-	-	-	✓	✓	-
Verpakking	Karton	Makpac	Karton	Makpac	Makpac	Karton	Karton	Karton
Gewicht	2,4 kg	2,4 kg	2,4 kg	2,4 kg	2,7 kg	2,4 kg	2,7 kg	2,2 kg
Meegeleverde accessoires	-	2 x diamantschijf	-	2 x diamantschijf	1 x diamantschijf + beschermkap stofafzuiging	-	AVT-greep + Ezynut sluitmoer	-
Prijs in €	excl. btw							
	incl. btw							

HAAKSE SLIJPERS 125 MM / 150 MM



9565PCV01

9565PCV01 & 9566PCV01: Antivibratiehandgreep en dodemansschakelaar.



GA5050R: grote lepelschakelaar + gereedschapsloze beschermkap

	GA5050R	9565CRX1	9565PCV01	9566PCV01	GA6040C
Nominaal vermogen	1300 W	1400 W	1400 W	1400 W	1400 W
Toerental	11000 t.p.m.	11000 t.p.m.	2800-11500 t.p.m.	4000-10000 t.p.m.	4000-9000 t.p.m.
SJS	-	✓	✓	✓	✓
Ø schijf	125 mm	125 mm	125 mm	150 mm	150 mm
Dodemansschakelaar	✓	-	✓	✓	-
Gewicht	2,5 kg	2,6 kg	2,6 kg	2,7 kg	2,6 kg
Prijs in €	excl. btw				
	incl. btw				

HAAKSE SLIJPERS 125 MM



GA5021CY

GA5021CYX1: Inclusief antivibratiegreep en Ezynut sluitmoer

	GA5021C	GA5021CY	GA5021CYX1
Nominaal vermogen	1450 W	1450 W	1450 W
Toerental	10000 t.p.m.	10000 t.p.m.	10000 t.p.m.
Ø schijf	125 mm	125 mm	125 mm
Dodemansschakelaar	-	✓	✓
Gewicht	3 kg	3 kg	3 kg
Prijs in €	excl. btw		
	incl. btw		

10x
Doorslijpschijven
in blik



Ref.	Ø (mm)	Dikte (mm)	Ø asgat (mm)	Prijs	
				excl. btw	incl. btw
D-18770-10	125	1,2	22,23		

HAAKSE SLIJPERS 125 MM

- Bestand tegen langdurige hoge belasting dankzij verbeterde koeling
- Greepomtrek van slechts 205 mm
- Mechanische rem (GA5091, GA5093, GA5094)
- De AFT functie stopt de motor ogenblikkelijk wanneer de schijf blokkeert



	NIEUW	NIEUW	NIEUW	NIEUW	NIEUW	NIEUW
	GA5092X01	GA5090X01	GA5091X01	GA5095X01	GA5094	GA5093X01
Nominaal vermogen	1900 W	1900 W	1900 W	1900 W	1900 W	1900 W
Toerental	11500 min ⁻¹	2800-11500 min ⁻¹	2800-11500 min ⁻¹	11500 min ⁻¹	11500 min ⁻¹	2800-11500 min ⁻¹
Variabel toerental	-	✓	✓	-	-	✓
Mechanische rem	-	-	✓	-	✓	✓
Type Schakelaar	Schuifschakelaar	Schuifschakelaar	Schuifschakelaar	Lepelschakelaar	Lepelschakelaar	Lepelschakelaar
Dodemansschakelaar	-	-	-	✓	✓	✓
Gewicht	2,6 - 3,8 kg	2,6 - 3,8 kg	2,8 - 4,0 kg	2,7 - 3,8 kg	2,9 - 4,0 kg	2,9 - 4,0 kg
Prijs in €	excl. btw					
	incl. btw					

ACCESSOIRES

	Omschrijving	Artikel	Diameter	Dikte	Asgat	Reductiering	Specificatie	Hoogte segment	Verpakkings-eenheid	Prijs excl. btw	Prijs incl. btw
	Doorslijpschijf staal	P-53023	125 mm	1,0 mm	22,23 mm		A60R-BF		1		
	Doorslijpschijf inox	P-53045	125 mm	1,0 mm	22,23 mm		A60S-BF		1		
	Doorslijpschijf inox 'Fast cutting'	B-45733	125 mm	0,8 mm	22,23 mm		Z60T-BF		1		
	Doorslijpschijf inox 'Fast cutting'	B-45733-12	125 mm	0,8 mm	22,23 mm		Z60T-BF		12		
	Diamantschijf Comet	B-12778	125 mm	2,0 mm	22,23 mm	20 mm		10 mm	1		
	Doorslijpschijf staal	P-05773	230 mm	2,5 mm	22,23 mm		A30S4-BF		1		
	Doorslijpschijf inox	E-13764	230 mm	1,9 mm	22,23 mm		A60U-BF		1		
	Diamantschijf Comet	B-12784	230 mm	2,6 mm	22,23 mm			10 mm	1		

HAAKSE SLIJPERS 180 MM



	GA7050	GA7060	GA7082	GA7070X1	GA7070YX1
Nominaal vermogen	2000 W	2200 W	2800 W	2800 W	2800 W
Toerental	8500 t.p.m.	8500 t.p.m.	8500 t.p.m.	8500 t.p.m.	8500 t.p.m.
Dodemansschakelaar	✓	✓	-	-	✓
Draaibare achterhand-greep	-	-	-	✓	✓
Mechanische rem	-	-	-	✓	✓
Gewicht	4,5 kg	5,3 kg	6,0 kg	6,2 - 6,7 kg	6,1 - 6,6 kg
Prijs in €	excl. btw				
	incl. btw				

HAAKSE SLIJPERS 230 MM



GA9061R



GA9082



GA9060KD

Incl. diamantschijf

	GA9050	GA9060	GA9060KD	GA9082	GA9061R
Nominaal vermogen	2000 W	2200 W	2200 W	2700 W	2200 W
Toerental	6600 t.p.m.	6600 t.p.m.	6600 t.p.m.	6600 t.p.m.	6600 t.p.m.
Soft start	-	-	-	✓	✓
Dodemansschakelaar	✓	✓	✓	-	-
Draaibare achterhandgreep	-	-	-	-	-
Heropstartbeveiliging	-	-	-	-	✓
Gewicht	4,7 kg	5,6 kg	5,6 kg	6,1 kg	5,7 kg
Prijs in €	excl. btw				
	incl. btw				



HAAKSE SLIJPERS 230 MM



GA9040RF01



GA9030SF01



GA9070YX1



GA9071YX1:
Met gesloten handgreep

	GA9030SF01	GA9030RF01	GA9040SF01	GA9040RF01	GA9080X1	GA9070X1	GA9070YX1	GA9071X1	GA9071YX1
Nominaal vermogen	2400 W	2400 W	2600 W	2600 W	2700 W	2800 W	2800 W	2800 W	2800 W
Toerental	6600 t.p.m.	6600 t.p.m.	6600 t.p.m.	6600 t.p.m.	6600 t.p.m.	6600 t.p.m.	6600 t.p.m.	6600 t.p.m.	6600 t.p.m.
Dodemansschakelaar	✓	-	✓	-	-	-	✓	-	✓
Draaibare achterhandgreep	✓	✓	✓	✓	✓	✓	✓	✓	✓
Antivibratie zijhandgreep	✓	✓	✓	✓	-	✓	✓	✓	✓
Soft start	✓	✓	✓	✓	✓	✓	✓	✓	✓
Heropstartbeveiliging	-	✓	-	✓	✓	✓	✓	✓	✓
Mechanische rem	-	-	-	-	-	✓	✓	✓	✓
Gewicht	6,3 kg	6,5 kg	6,7 kg	6,9 kg	6,4 kg	6,3 kg	6,3 - 8,5 kg	6,4 kg	6,3 - 8,5 kg
Prijs in €	excl. btw								
	incl. btw								

STEMPELSLIJERS



G55000



GD0811C



GD0810C



GD0603

	GD0600	GD0603	GD0800C	GD0810C	GD0801C	GD0811C	G55000
Nominaal vermogen	400 W	240 W	750 W	750 W	750 W	750 W	750 W
Toerental	25000 t.p.m.	28000 t.p.m.	7000-28000 t.p.m.	1800-7000 t.p.m.	7000-28000 t.p.m.	1800-7000 t.p.m.	5600 t.p.m.
Ø spantang - bereik	6 mm	6 mm	6-8 mm	6-8 mm	6-8 mm	6-8 mm	20 mm
Ø spantang - inbegrepen	6 mm	6 mm	6 mm	6 mm	6 mm	6 mm	20 mm
Lepelschakelaar	✓	-	-	-	✓	✓	-
Dodemansschakelaar	-	-	-	-	✓	✓	✓
Gewicht	1,7 kg	0,97 kg	1,7 kg	1,7 kg	1,7 kg	2,0 kg	5,0 kg
Prijs in €	excl. btw						
	incl. btw						

COMBOPACK SLIJERS



125 mm

GA9060

230 mm

9558HNRG

	DK0047GX1	DK0046X1
Haakse slijper 230 mm	GA9060	GA9061R
Haakse slijper 125 mm	9558HNRG	GA5040RZ
Diamantschijf	2 x Diamak DS	2 x Diamak DS
Synthetische koffer	✓	✓
Prijs in €	excl. btw	
	incl. btw	

COMBOPACK KLOPBOORMACHINE + HAAKSE SLIJER



DK0050X1

Klopboormachine 710 W	HP1631
Haakse slijper 125 mm	GA5030R
Borensset	D-08660
Synthetische koffer	✓
Prijs in €	excl. btw
	incl. btw

COMBOPACK HAAKSE SLIJER + STOFZUIGING



Inclusief stofafzuiging 196845-3 t.w.v.



	DK9525
Haakse slijper 125 mm 1400 W	9565CRX1
Stofzuiger	VC2510LX1
Prijs in €	excl. btw
	incl. btw

COMBOPACK SCHUURMACHINE + STOFZUIGER



	DK6525
Schuurmachine	BO6050J
Stofzuiger	VC2510LX1
Prijs in €	excl. btw
	incl. btw

METAALAFKORTMACHINES

LC1230N

- Inclusief HM zaagblad
- verstekhoek instelbaar op 45°



LW1400X



LC1230N

LW1400X LC1230N

Nominaal vermogen	2200 W	1750 W
Type schijf	doorslijpschijf	zaagblad
Toerental	3800 t.p.m.	1300 t.p.m.
Zaagdiepte (90°)	115 mm	100 mm
Ø Zaagblad	355 mm	305 mm
Gewicht	17,2 kg	19,3 kg
Prijs in €	excl. btw	
	incl. btw	

BETONSCHAVEN

PC5001C
Geleverd met komschijf B-12289



PC50001C

PC5010C

PC5010C PC5001C

Nominaal vermogen	1400 W	1400 W
Ø schijf	125 mm	125 mm
Gewicht	2,5 kg	5,1 kg
Prijs in €	excl. btw	
	incl. btw	

PC5010C:
Instelbaar toerental

MUURFREZEN



SG150



SG181

SG1251J SG150 SG181

Nominaal vermogen	1400 W	1800 W	2150 W
Max. slijpdiepte	30 mm	45 mm	60 mm
Sleufbreedte	6-30 mm	7-35 mm	7-43 mm
Ø schijf	125 mm	150 mm	180 mm
Gewicht	4,4 kg	5,7 kg	6 kg
Prijs in €	excl. btw		
	incl. btw		

DIAMANTZAAG



4114S

Nominaal vermogen	2400 W
Max. slijpdiepte	125 mm
Ø schijf	350 mm
Ø asgat	25,4 mm
Gewicht	10,8 kg
Prijs in €	excl. btw
	incl. btw

DIAMANTZAAG



4100KB

Nominaal vermogen	1400 W
Zaagdiepte (90°)	40 mm
Ø Zaagblad	125 mm
Gewicht	3,0 kg
Prijs in €	excl. btw
	incl. btw

MOTORDOORSLIJPERS



	EK6100	EK7301WS	EK7651H
Motor	2-takt	2-takt	4-takt
Cilinderinhoud	60,7 cc	72,6 cc	75,6 cc
Vermogen	3,2 kW/4,3 pk	3,8 kW/5,2 pk	3,0 kW/4,1 pk
Maximaal nettokoppel	3,9 Nm	4,3 Nm	4,6 Nm
Ø schijf	300 mm	350 mm	350 mm
Decompressieklep	-	✓	✓
Gewicht	8,5 kg	10 kg	12,9 kg
Prijs in €	excl. btw		
	incl. btw		

DIAMANTSCHIJVEN

	Artikel	Ø	Dikte	Hoogte segment	Ø asgat	Reductiering	Prijs excl. btw	Prijs incl. btw
Quasar	B-17588	300 mm	3,0 mm	12 mm	25,4 mm	20 mm		
	B-13465	350 mm	3,0 mm	12 mm	25,4 mm	20 mm		
	B-13471	400 mm	3,0 mm	12 mm	25,4 mm	20 mm		
Comet	B-17619	300 mm	3,0 mm	10 mm	25,4 mm	20 mm		
	B-13552	350 mm	3,0 mm	10 mm	25,4 mm	20 mm		
	B-13568	400 mm	3,0 mm	10 mm	25,4 mm	20 mm		
Asfalt	B-13275	350 mm	3,2 mm	10 mm	25,4 mm	20 mm		
	B-42905	400 mm	3,2 mm	10 mm	25,4 mm	20 mm		

	Artikel	Ø extern	Ø intern	Dikte	Prijs excl. btw	Prijs incl. btw
Reductieringen	257199-4	22,23 mm	20,00 mm	3,0 mm		
	197318-9	25,4 mm	20,00 mm	5 mm		

SLIJPMOLENS



GB801



	GB602W	GB801
Nominaal vermogen	250 W	550 W
Toerental	2850 t.p.m.	2850 t.p.m.
Ø Slijpsteen	150 mm	205 mm
Gewicht	9 kg	19,8 kg
Prijs in €	excl. btw	
	incl. btw	

LINTZAAGMACHINE



B-42581
Schuurbanden 20 x 2240 mm
Rood • Korrel 80

B-42597
Schuurbanden 20 x 2240 mm
Rood • Korrel 120

JM21000330
Adapterset voor schuurbanden

	LB1200F
Nominaal vermogen	900 W
Breedte zaaglint	6-16 mm
Gewicht	81,2 kg
Prijs in €	excl. btw
	incl. btw

RECIPROZAGEN



JR3070CT

	JR3051TK	JR3061T	JR3070CT
Nominaal vermogen	1200 W	1250 W	1510 W
Aantal zaagbewegingen	0-3000 /min	0-2800 /min	0-2800 /min
AVT	-	-	✓
Pendelinstelling	-	-	✓
Slaglengte	30 mm	32 mm	32 mm
Vibratieniveau	19,5 m/s ²	23,5 m/s ²	8,5 m/s ²
Gewicht	3,2 kg	4,4 kg	4,4 kg
Prijs in €	excl. btw		
	incl. btw		

LAMELLENFREES



Revolver diepte-instelling met 6 preselecties voor een snelle afstelling.

Aanslagplaat met tandheugelverstelling voor een snelle en precieze aanpassing aan de materiaaldikte.

Kantelbare voetplaat met handige vergrendelingshendel en automatische stops op 0°, 45° en 90°.

		PJ7000J
Nominaal vermogen		700 W
Toerental		11000 t.p.m.
Ø zaagblad		100 mm
Asgat		22 mm
Gewicht		2,5 kg
Prijs in €	excl. btw	
	incl. btw	

MULTITOOL



INCLUSIEF:
Set van 9 accessoires,
30 schuurvellen en 1 afzuigset



**GEREEDSCHAPSLOZE
ACCESSOIREWISSEL**

		TM3010CX3J
Nominaal vermogen		320 W
Oscillatiefrequentie		6000-20000/min
Oscillatiehoek		3,2°
Gewicht		1,6 kg
Prijs in €	excl. btw	
	incl. btw	

VANDIKTEBANK



		2012NB
Nominaal vermogen		1650 W
Toerental		8500 t.p.m.
Breedte		304 mm
Max. doorlaathoogte		155 mm
Max. spaanafname		3 mm
Gewicht		28,1 kg
Prijs in €	excl. btw	
	incl. btw	

KETTINGFREESMACHINES



	7104L	7104L-30
Nominaal vermogen	1140 W	1140 W
Toerental	3200 t.p.m.	3200 t.p.m.
Kettingsnelheid onbelast	5 m/s	5 m/s
Ketting	16,5 mm	30 mm
Gatbreedte	16,5-30 mm	30-45 mm
Gatlengte	54-130 mm	54-130 mm
Gewicht	17,3 kg	17,3 kg
Prijs in €	excl. btw	
	incl. btw	

BOVENFREZEN



RP1111CJ



RP2302FCXJ

RP2302FCXJ: Inclusief langsgelieder met fijnafstelling

	RP0900J	RP1111CJ	RP1802F	RP2302FCXJ
Nominaal vermogen	900 W	1100 W	1850 W	2300 W
Toerental	27000 t.p.m.	8000 - 27500 t.p.m.	23000 t.p.m.	9000-22000 t.p.m.
Max. induikdiepte	35 mm	57 mm	70 mm	70 mm
Ø Spantang - bereik	6-8 mm	6-8 mm	6-12 mm	6-12 mm
Ø Spantang - inbegrepen	8 mm	8 mm	6, 8, 12 mm	6, 8, 12 mm
Verpakking	Makpac	Makpac	Karton	Makpac
Gewicht	2,7 kg	3,3 kg	6,2 kg	6,1 kg
Prijs in €	excl. btw			
	incl. btw			

KANTENFREZEN



3711



3712

3712: Inclusief kantelbare zool

	3711	3712
Nominaal vermogen	530 W	530 W
Toerental	32000 t.p.m.	32000 t.p.m.
Max. induikdiepte	42 mm	42 mm
Spantang	6 mm	6 mm
Gewicht	1,5 kg	1,7 kg
Prijs in €	excl. btw	
	incl. btw	

BOVEN- EN KANTENFREES



4 MACHINES IN 1

- Rechte kantenfrees
- Verstelbare kantenfrees
- Kantenfrees met verschoven spindel
- Bovenfrees

Rechte kantenfrees
Regelbare freesdiepte van 0 tot 40 mm

Verstelbare kantenfrees
Hoekinstelling tussen -30° en 45°

Kantenfrees met verschoven spindel om zo dicht mogelijk tegen een obstakel te werken

Bovenfrees
Diepteregeling per 1/10 van een mm van 0 tot 35 mm

RT0702CX3J

Nominaal vermogen	710 W
Toerental	10000-30000 t.p.m.
Max. induikdiepte	35 mm
Ø Spantang - bereik	6 - 8 mm
Ø Spantang - inbegrepen	6 mm, 8 mm
Gewicht	1,8 kg
Prijs in €	excl. btw
	incl. btw

SCHAVEN



KP0810CJ

1100

	KP0800J	KP0810J	KP0810CJ	1100	1911BJ	1806B	KP312S
Nominaal vermogen	620 W	850 W	1050 W	950 W	900 W	1200 W	2200 W
Toerental	17000 t.p.m.	16000 t.p.m.	12000 t.p.m.	16000 t.p.m.	16000 t.p.m.	18000 t.p.m.	12000 t.p.m.
Breedte	82 mm	82 mm	82 mm	82 mm	110 mm	170 mm	312 mm
Max. spaanafname	2,5 mm	4 mm	4 mm	3 mm	2 mm	2 mm	3,5 mm
Gewicht	2,6 kg	3,3 kg	3,4 kg	5,1 kg	4,3 kg	9,0 kg	18,4 kg
Prijs in €	excl. btw						
	incl. btw						

DECOUPEERZAGEN



4350FCTJ



4351FCTJ



JV0600J



4329K



	4326	4329K	JV0600J	4350FCTJ	4351FCTJ
Nominaal vermogen	450 W	450 W	650 W	720 W	720 W
Aantal zaagbewegingen	3100 /min	500-3100 /min	500-3100 /min	800-2800 /min	800-2800 /min
Max. capaciteit hout	65 mm	65 mm	90 mm	135 mm	135 mm
Makpac	-	-	✓	✓	✓
Gewicht	1,8 kg	1,9 kg	2,4 kg	2,6 kg	2,5 kg
Prijs in €	excl. btw				
	incl. btw				

COMBOPACK

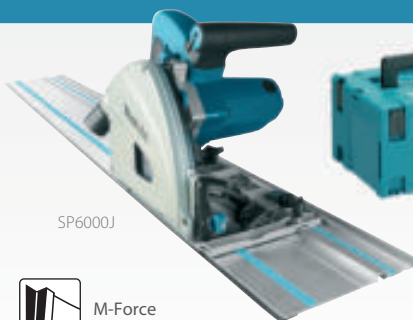

SP6000J



M-Force



4351FCTJ

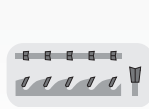

MEU029J

Invalcirkelzaag	SP6000J
Decoupeerzaag	4351FCTJ
Geleiderail 1400 mm	194368-5
Extra cirkelzaagblad	B-32007
Decoupeerzaagbladen	5
Draagtas	B-57613
Prijs in €	excl. btw
	incl. btw

INVALCIRKELZAAG

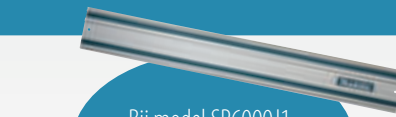

Bij model SP6000J1
2 x geleiderail 1,4 m
+ koppelstrips

	SP6000J	SP6000J1
Nominaal vermogen	1300 W	1300 W
Zaagdiepte (90°)	57 mm	57 mm
Zaagdiepte (45°)	40 mm	40 mm
Max. zaagdiepte (48°)	38 mm	38 mm
Ø Zaagblad	165 mm	165 mm
Gewicht	4,4 kg	4,4 kg
Prijs in €	excl. btw	
	incl. btw	

CIRKELZAGEN



5008MGJX



Zaagblad gratis bij 5008MGJX t.w.v.



HS7101JX



2 x zaagblad 12 tanden bij HS7101JX t.w.v.
2 x zaagblad 16 tanden bij 5903RKX1 t.w.v.



HS0600



5143R

	HS6601	HS6101J	HS7601J	HS7101JX	5008MGJX	5903RKX1	HS0600	5103R	5143R
Nominaal vermogen	1050 W	1100 W	1200 W	1400 W	1800 W	2000 W	2000 W	2100 W	2200 W
Zaagdiepte (90°)	54,5 mm	54,5 mm	66 mm	67 mm	75,5 mm	85 mm	101 mm	100 mm	130 mm
Ø Zaagblad	165 mm	165 mm	190 mm	190 mm	210 mm	235 mm	270 mm	270 mm	355 mm
Gewicht	3,7 kg	3,7 kg	4,0 kg	4,0 kg	5,1 kg	7,2 kg	6,9 kg	9,4 kg	14,0 kg
Prijs in €	excl. btw								
	incl. btw								

TAFEL-, AFKORT- EN VERSTEKZAGEN



LF1000



LF1000



LH1201FL

SNELLE OMBOUW
VAN TAFEL- NAAR
AFKORTZAAGFUNCTIE

Verstekhoek	LH1040	LH1201	LF1000
	90°	91 x 95 mm 69 x 130 mm	95 x 155 mm 62 x 200 mm
45°	69 x 85 mm	62 x 125 mm	50 x 150 mm

		LH1040F	LH1201FL	LF1000
Nominaal vermogen		1650 W	1650 W	1650 W
Ø Zaagblad		260 mm	305 mm	260 mm
Gewicht		14,3 kg	20,7 kg	36 kg
Prijs in €	excl. btw			
	incl. btw			

AFKORT-VERSTEKZAAG



Kantelbaar naar links tot 45°

		LS1040N
Nominaal vermogen		1650 W
Ø Zaagblad		260 mm
Max. zaagdiepte 0°		91 x 95 mm
Max. zaagdiepte 45°		91 x 67 mm
Gewicht		12,4 kg
Prijs in €	excl. btw	
	incl. btw	

TAFELZAAG MET ONDERSTEL



		2704NX1
Nominaal vermogen		1650 W
Ø Zaagblad		260 mm
Gewicht		34,9 kg
Prijs in €	excl. btw	
	incl. btw	

TAFELZAAG



		MLT100N
Nominaal vermogen		1500 W
Ø Zaagblad		260 mm
Gewicht		34,7 kg
Prijs in €	excl. btw	
	incl. btw	



BOUWCIRKELZAAG



		2712
Nominaal vermogen		2000 W
Ø Zaagblad		315 mm
Gewicht		52,9 kg
Prijs in €	excl. btw	
	incl. btw	

TELESCOPISCHE AFKORT-VERSTEKZAGEN

PROMO

Gratis onderstel DEBWST06 t.w.v. bij LS1019L/LS1219L

Model	DEBWST06 - Onderstel
LS1019	✓  t.w.v.
LS1219	✓

Max. lengte: 2550 mm

Nieuwe bevestigingsklemmen voor het bevestigen van verstekzagen op onderstellen DEBWST06 en DEAWST07



JM00000219

DXT

Deep and Exact Cutting Technology

De gepatenteerde constructie met drievoudige tandwieloverbrenging en uitsparing achter de flens laat toe om een groter deel van het zaagblad te benutten. Daardoor kunnen ook hoge plinten verticaal of in verstek afgekort worden.



LS1019L

LS1018L

Verstekhoek	LS1219L - Snijhoek		
	45° links	0°	45° rechts
0°	71x363 mm	107x363 mm	54x363 mm
45° L EN R	71x255 mm	107x255 mm	54x255 mm
60° L EN R	-	107x178 mm	-
PLINTEN	-	171 mm	-

Verstekhoek	LS1019L - Snijhoek		
	45° links	0°	45° rechts
0°	61x279 mm	91x279 mm	43x279 mm
45° L EN R	61x197 mm	91x197 mm	43x197 mm
60° L EN R	-	91x139 mm	-
PLINTEN	-	133 mm	-

Verstekhoek	LS0815FL - Snijhoek		
	45° links	0°	5° rechts
0°	50x305 mm	65x305 mm	60x305 mm
45° L EN R	50x215 mm	65x215 mm	-
60° R	-	65x150 mm	-

Verstekhoek	LS1018LN - Snijhoek		
	45° links	90°	45° rechts
0°	50x310 mm	91x310 mm	31x310 mm
45° L EN R	50x220 mm	91x220 mm	31x220 mm
60° R	-	91x153 mm	-

Verstekhoek	LS0714FLB - Snijhoek		
	45° links	90°	45° rechts
0°	40x300 mm	52x300 mm	40x300 mm
45° L EN R	40x212 mm	52x212 mm	-
57° R	-	52x163 mm	-

	LS0815FLN	LS1018LN	LS0714LN	LS1019L	LS1219L
Nominaal vermogen	1400 W	1430 W	1010 W	1510 W	1800 W
Ø zaagblad	216 mm	260 mm	190 mm	260 mm	305 mm
DXT	-	-	-	✓	✓
Gewicht	14,2 kg	19,9 kg	13,4 kg	26,3 kg	29,5 kg
Prijs in €	excl. btw				
	incl. btw				

ONDERSTEL AFKORT-VERSTEKZAGEN



Verbeterde bevestigingsklemmen!

- Ideaal voor het zagen van lange materialen
- Vernieuwde bevestigingsklemmen met een veilig en handig kliksysteem om moeiteloos verstekzagen te installeren en te demonteren.
- Gemakkelijk te transporteren

		DEAWST07
Afmetingen		1765 (l) x 750 (b) x 850 (h) mm
Max. lengte		3830 mm
Prijs in €	excl. btw	
	incl. btw	

HANDPALMVLAKSCHUURMACHINES



	BO4556K	BO4555K	BO4558	BO4565K
Nominaal vermogen	200 W	200 W	200 W	200 W
Afmetingen schuurvoet	112 x 102 mm	112 x 102 mm	112 x 102 mm	112 x 190 mm
Bevestiging	Klem	Velcro & klem	Klem	Velcro Driehoekspunt
Materiaal schuurvoet	Kunststof	Kunststof	Aluminium	Kunststof
Aantal schuurbewegingen	14000/min	14000/min	14000 /min	14000/min
Schuuruitslag	1,5 mm	1,5 mm	1,5 mm	1,5 mm
Gewicht	1,1 kg	1,1 kg	1,2 kg	1,2 kg
Prijs in €	excl. btw			
	incl. btw			



VLAKSCHUURMACHINES MET VARIABLE SNELHEID



BO3711

	BO3711	BO4900VJ
Nominaal vermogen	190 W	330 W
Afmetingen schuurvoet	93 x 185 mm	115 x 232 mm
Aantal schuurbewegingen	4000-11000/min	4000-10000/min
Schuuruitslag	2,0 mm	2,6 mm
Gewicht	1,6 kg	2,7 kg
Prijs in €	excl. btw	
	incl. btw	

BANDSCHUURMACHINES

9403J:
Zeer krachtig,
ideaal voor intensief
schuurwerk

9403J

9911J

9032



	9911J	9924DB	9903J	9031	9032	9920J	9404J	9403J
Nominaal vermogen	650 W	850 W	1010 W	550 W	500 W	1010 W	1010 W	1200 W
Bandsnelheid	75-270 m/min	400 m/min	210-440 m/min	200-1000 m/min	300-1700 m/min	210-440 m/min	210-440 m/min	500 m/min
Schuurband	75 x 457 mm	75 x 610 mm	75 x 533 mm	30 x 533 mm	9 x 533 mm	75 x 610 mm	100 x 610 mm	100 x 610 mm
Gewicht	2,7 kg	4,8 kg	4,3 kg	2,1 kg	1,6 kg	4,5 kg	4,8 kg	5,7 kg
Prijs in €	excl. btw							
	incl. btw							

EXCENTRISCHE SCHUURMACHINES



BO5031K



BO5041K



BO6050J

	BO5031K	BO5041K	BO6030JX	BO6050J
Nominaal vermogen	300 W	300 W	310 W	750 W
Aantal schuurbewegingen	8000-24000/min	8000-24000/min	8000-20000/min	3200-13600/min
Schuuruitslag	2,8 mm	2,8 mm	3 mm	5,5 mm
Ø Schuurvoet	123 mm	123 mm	147 mm	147 mm
Gewicht	1,3 kg	1,4 kg	2,4 kg	2,6 kg
Prijs in €	excl. btw			
	incl. btw			

HAAKSE SCHUURMACHINE



SA7000C

SA7000C	
Nominaal vermogen	1600 W
Toerental onbelast	0-4000 t.p.m.
Ø schijf	180 mm
Gewicht	3,4 kg
Prijs in €	excl. btw
	incl. btw

EXCENTRISCHE POLIJSTMACHINE



PO6000C

PO6000C	
Nominaal vermogen	890 W
Aantal schuurbewegingen	0-13600 /min.
Ø schijf	150 mm
Schuuruitslag	5,5 mm
Gewicht	2,7 kg
Prijs in €	excl. btw
	incl. btw

SCHUUR- EN POETSMACHINE



9237CB

9237CB	
Nominaal vermogen	1200 W
Toerental	0-3200 t.p.m.
Ø schijf	180 mm
Gewicht	3,4 kg
Prijs in €	excl. btw
	incl. btw

BORSTELSCUURMACHINE



9741J

9741J	
Nominaal vermogen	860 W
Toerental	3500 t.p.m.
Gewicht	4,2 kg
Prijs in €	excl. btw
	incl. btw

GASNAGELPISTOOL VOOR
AFWERKNAGELS 16 GA



GF600SE

Accu	7,2 V / 1,0 Ah
Gemiddelde laadtijd	30 min
Doorsnede nagel	1,6 mm
Lengte nagel	15-64 mm
Gewicht	2,2 kg
Prijs in €	excl. btw
	incl. btw

GASNAGELPISTOOL
VOOR BETON



GN420CSE

Accu	7,2 V / 1,0 Ah
Gemiddelde laadtijd	30 min
Doorsnede nagel	2,6-3,0 mm
Lengte nagel	15-40 mm
Gewicht	3,5 kg
Prijs in €	excl. btw
	incl. btw

GASNAGELPISTOOL VOOR HOUT



GN900SE

Accu	7,2 V / 1,0 Ah
Gemiddelde laadtijd	30 min
Doorsnede nagel	2,9-3,3 mm
Lengte nagel	50-90 mm
Gewicht	3,3 kg
Prijs in €	excl. btw
	incl. btw

PNEUMATISCH NIETPISTOOL 18 GA



AT638A

Werkdruk	4,2 - 8 bar
Draadkaliber	18 Ga
Doorsnede niet	1,1x1,3 mm
Rugbreedte niet	5 mm
Lengte niet	15-38 mm
Gewicht	1,5 kg
Prijs in €	excl. btw
	incl. btw

PNEUMATISCH ROLNAGELPISTOOL



AN454

Werkdruk	4,9-8,3 bar
Doorsnede nagel	3,05 mm
Lengte nagel	19-45 mm
Gewicht	2,4 kg
Prijs in €	excl. btw
	incl. btw

PNEUMATISCH CONSTRUCTIE-
NAGELPISTOOL 21°



AN924

Werkdruk	4,9-8,3 bar
Doorsnede nagel	3,76 mm
Lengte nagel	50-90 mm
Gewicht	3,8 kg
Prijs in €	excl. btw
	incl. btw

MINIBRADPISTOOL 18 GA



AF506

Werkdruk	4,8-8,3 bar
Draadkaliber	18 Ga
Ø Nagelkop	2,0 mm
Doorsnede nagel	1,2 mm
Lengte nagel	15-50 mm
Gewicht	1,4 kg
Prijs in €	excl. btw
	incl. btw

BRADPISTOOL 16 GA



AF601

Werkdruk	0,49 - 8,3 bar
Draadkaliber	16 Ga
Doorsnede nagel	1,6 mm
Lengte nagel	25 - 64 mm
Gewicht	1,7 kg
Prijs in €	excl. btw
	incl. btw

PNEUMATISCH
CONSTRUCTIENAGELPISTOOL 34°



AN943K

Werkdruk	4,5-8,5 bar
Ø Nagelkop	7,0 mm
Doorsnede nagel	2,9-3,3 mm
Lengte nagel	50-90 mm
Gewicht	3,9 kg
Prijs in €	excl. btw
	incl. btw

LASERAFSTANDSMETER



LD080PI



LD030P



	LD030P	LD050P	LD080PI
Bereik	30 m	50 m	80 m
Gewicht	0,1 kg	0,1 kg	0,1 kg
Prijs in €	excl. btw		
	incl. btw		

ROTARENDE LASER



INCLUSIEF:
statief 2,7 m
t.w.v.



Inclusief ontvanger, bril voor laser, afstandsbediening en wandbevestiging

		SKR200Z
Rotatiesnelheid		0-600 t.p.m.
Bereik		100 m
Gewicht		1,6 kg
Prijs in €	excl. btw	
	incl. btw	

ACCU MUURSCANNER



4,1 inch kleurscherm



De DWD181 gebruikt radartechnologie om nauwkeurig metaal, hout, elektrische bekabeling en andere objecten in wanden en vloeren te detecteren

		DWD181Z
Spanning		14,4 V/18 V
Max. detectiediepte		25 - 180 mm
Tolerantie detectiediepte		± 5 mm
Minimum detecteerbare afstand tussen objecten		40 mm
Bijgeleverde lader/accu		-
Gewicht zonder accu		1,0 kg
Prijs in €	excl. btw	
	incl. btw	

KRUISLIJN- EN LIJNLASERS (CXT)

SK105DZ, SK105GDZ,
SK106DZ & SK106GDZ
INCLUSIEF:
BL1021B + DC10SB



SK105DZ



SK106GDZ

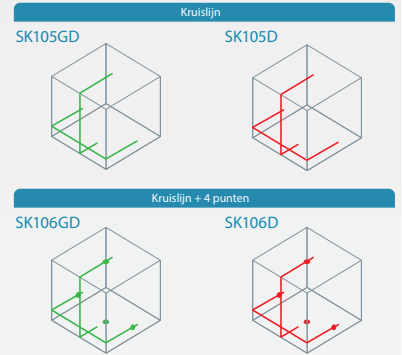

	SK105DZ	SK105GDZ	SK106DZ	SK106GDZ
Kleur	Rood	Groen	Rood	Groen
Projecties	1 H - 1 V	1 H - 1 V	1 H - 1 V + 4 punten	1 H - 1 V + 4 punten
Nauwkeurigheid	+3 mm / 10 m	+3 mm / 10 m	+3 mm / 10 m	+3 mm / 10 m
Bereik	25 m	25 m	25 m	25 m
Bijgeleverde accu's	1 x BL1021B + DC10SB	1 x BL1021B + DC10SB	1 x BL1021B + DC10SB	1 x BL1021B + DC10SB
Gewicht	0,67 kg	0,67 kg	0,69 kg	0,69 kg
Prijs in €	excl. btw			
	incl. btw			

SK10GD/SK20GD/SK40GD

- Groene laser met hoge helderheid
- Uiterst nauwkeurig
- Stevige constructie, beschermingsklasse IP54

Horizontaal /
4-Verticale lijnen

Horizontaal /
2-Verticale lijnen

Kruislijn + Punt

SK40GD

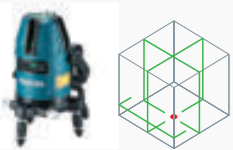

SK20GD



SK10GD

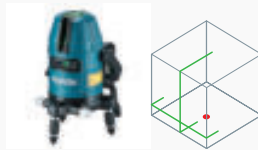

SK10GDZ, SK20GDZ, SK40GDZ
SK209GDZ & SK312GDZ
INCLUSIEF:
Powerpack 197658-5



1 horizontale + 2 verticale lijnen
SK209GDZ



1 horizontale + 3 verticale lijnen
SK312GDZ



SK209GDZ



SK312GDZ

	SK10GDZ	SK20GDZ	SK40GDZ	SK209GDZ	SK312GDZ
Kleur	Groen	Groen	Groen	Groen	Groen
Projecties	1 H - 1 V	1 H - 2 V + loodpunt	1 H - 4 V + loodpunt	1 H - 2 V + loodpunt	1 H - 3 V + loodpunt
Nauwkeurigheid	±1 mm/10m	±1 mm/10m	±1 mm/10m	+1 mm/10m	+1 mm/10m
Bereik	-	-	-	-	-
Bijgeleverde accu's	2x BL1021B + DC10SB	2x BL1021B + DC10SB	2x BL1021B + DC10SB	2x BL1021B + DC10SB	2x BL1021B + DC10SB
Gewicht	1,4 - 1,6 kg	1,4 - 1,6 kg	1,4 - 1,6 kg	1,5 - 1,6 kg	1,5 - 1,6 kg
Prijs in €	excl. btw				
	incl. btw				

KRUISLIJN- EN LIJNLASERS (CXT)

SK700DZ/SK700GDZ:

- 3x 360° laser (3 stralen: 1 horizontaal 360° + 2 verticaal 360°).
- Zeer hoge nauwkeurigheid.
- Blokkeerstand voor projectie van schuine lijnen en voor transport.
- Zeer grote autonomie dankzij de 12Vmax CXT batterij.
- IP54 bescherming.

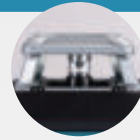

Via een sneldraaiende conische spiegel wordt de laserstraal over 360° geprojecteerd.

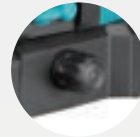

Fijnafstelling: Via een knop op de basis kan de unit zeer precies over een bereik van 10° gedraaid worden. De bevestiging is excentrisch zodat de kruising van de lijnen bij het draaien op hetzelfde punt blijft.

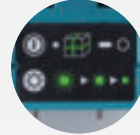

Helderheidsinstelling
Via de 3 helderheidsinstellingen (100% – 75% – 50%) kan de intensiteit van de laser perfect aangepast worden aan de omstandigheden.

Hoge intensiteit
De SK700GDZ met krachtige groene laser biedt een uitstekende zichtbaarheid, ook in een omgeving met invallend daglicht.



SK700DZ



SK700GDZ



SK700DZ & SK700GDZ
INCLUSIEF:
Powerpack 197658-5



OPTIONEEL CP0000001
ADP09 Batterij adapter voor SK700
Werkt met 8 x 1,5V AA-batterijen
excl btw:
incl btw:



	SK700DZ	SK700GDZ
Kleur	Rood	Groen
Projecties	3 x 360° rood	3 x 360° groen
Nauwkeurigheid	±2mm/10m	±2mm/10m
Bereik	25 m	35 m
Bijgeleverde accu's	2x BL1021B + DC105B	2x BL1021B + DC105B
Gewicht	0,99 – 1,2 kg	0,99 – 1,2 kg
Prijs in €	excl. btw	
	incl. btw	

Accessories

TK0LM2000F
Statief 400 - 1140 mm
excl btw:
incl btw:



TK0LM4001F
Statief 680 - 1800 mm
excl btw:
incl btw:



TK0LM5030F
Statief 780 - 2900 mm
excl btw:
incl btw:



LE00870137
Muur- en plafondbevestiging
SK105, SK106, SK700
excl btw:
incl btw:



TK00ET03F1
Muur- en plafondbevestiging
SK10, SK20, SK40,
SK209, SK312
excl btw:
incl btw:



LE00855702
Laserlijntonvanger (80 m)
SK105, SK106, SK700
excl btw:
incl btw:



TK0LDG501G
Laserlijntonvanger SK10,SK20,
SK40
excl btw:
incl btw:



TK0LDG301G
Laserlijntonvanger SK209,
SK312
excl btw:
incl btw:



DECADP05
Adapter voor
LXT batterijen
excl btw:
incl btw:



199178-5
USB voedingskabel voor
ADP05 (SK105 / SK106)
excl btw:
incl btw:



199010-3
USB voedingskabel voor
ADP05 (SK209 / SK312)
excl btw:
incl btw:



DLM330

ACCU GRASMAAIERS 18V



DLM330SM

		DLM330Z	DLM330SM
Spanning		1 x 18V	1 x 18V
Bijgeleverde accu's		-	1 x accu 4,0 Ah
Bijgeleverde Lader		-	DC18SD
Max. uitgangsvermogen		450 W	450 W
Maaibreedte		33 cm	33 cm
Aanbevolen terreinoppervlakte		200 - 450 m ²	200 - 450 m ²
Chassis		Polypropyleen	Polypropyleen
Zelftrekkend			
Inhoud opvangbak		30 l	30 l
Mulching		✓	✓
Gewicht		11,6 - 12,5 kg	11,6 - 12,5 kg
Prijs in €	excl. btw		
	incl. btw		

DLM432

ACCU GRASMAAIERS 2 x 18V



DLM432PT2

		DLM432Z	DLM432PT2
Spanning		2 x 18V	2 x 18V
Bijgeleverde accu's		-	2 x accu 5,0 Ah
Bijgeleverde Lader		-	DC18RD
Max. uitgangsvermogen		900 W	900 W
Maaibreedte		43 cm	43 cm
Aanbevolen terreinoppervlakte		300 - 575 m ²	300 - 575 m ²
Chassis		Polypropyleen	Polypropyleen
Zelftrekkend		-	-
Inhoud opvangbak		50 l	50 l
Mulching		Optioneel	Optioneel
Gewicht		14,3 kg	14,3 kg
Prijs in €	excl. btw		
	incl. btw		

"Max aanbevolen maaiooppervlakte"

is de maximum oppervlakte waar de machine qua vermogen, mechaniek en werkbreedte voor geschikt is.

Opgelet, dit komt niet noodzakelijk overeen met de autonomie, die afhankelijk is van het type batterijen dat gebruikt wordt en de maaiomstandigheden (de hoogte en dichtheid van het gras, de helling van het terrein enz.)

Dus het kan voorkomen dat de accu's tussenin bijgeladen moeten worden om de volledige oppervlakte te kunnen maaien.

DLM480 / DLM481 / DLM539

ACCU GRASMAAIERS 2 x 18V



PROMO

Gratis BL1850B na online registratie DLM539CT2



DLM481CT2

DLM539CT2

		DLM480CT2	DLM481CT2	DLM539CT2
Spanning		2 x 18V	2 x 18V	2 x 18V
Bijgeleverde accu's		2 x accu 5,0 Ah	2 x accu 5,0 Ah	2 x accu 5,0 Ah
Bijgeleverde Lader		DC18SH	DC18SH	DC18SH
Max. uitgangsvermogen		860 W	860 W	860 W
Maaibreedte		48 cm	48 cm	53,4 cm
Aanbevolen terreinoppervlakte		400 - 800 m ²	400 - 800 m ²	500 - 1000 m ²
Chassis		Polypropyleen	Polypropyleen	Polypropyleen
Zelftrekkend		-	✓	✓
Inhoud opvangbak		62 l	62 l	70 l
Mulching		✓	✓	✓
Gewicht		24,5 - 26,8 kg	27,1 - 29,3 kg	28,0 - 30,5 kg
Prijs in €	excl. btw			
	incl. btw			

DLM463 / DLM465

ACCU GRASMAAIERS 2 x 18V

PROMO

Gratis BL1850B na online registratie



DLM463PT2



DLM465PT2

		NIEUW DLM463Z	NIEUW DLM463PT2	NIEUW DLM465Z	NIEUW DLM465PT2
Spanning		2x 18V	2x 18V	2x 18V	2x 18V
Bijgeleverde accu's		-	2x 5,0 Ah	-	2x 5,0 Ah
Bijgeleverde lader		-	DC18RD	-	DC18RD
Max. uitgangsvermogen		1450 W	1450 W	1600 W	1600 W
Maaibreedte		46 cm	46 cm	46 cm	46 cm
Aanbevolen terreinoppervlakte		800 - 1600 m ²	800 - 1600 m ²	1600 - 1800 m ²	1600 - 1800 m ²
Chassis		Staal	Staal	Staal	Staal
Zelftrekkend		-	-	✓	✓
Inhoud opvangbak		60 l	60 l	60 l	60 l
Mulching		✓	✓	✓	✓
Gewicht		25,3 - 27,6 kg	25,3 - 27,6 kg	35,3 - 39,0 kg	35,3 - 39,0 kg
Prijs in €	excl. btw				
	incl. btw				

DLM536 / DLM533

ACCU GRASMAAIERS 2 x 18V

PROMO

Gratis BL1850B
na online registratie

18V + 18V

36V

XPT
EXTREME PROTECTION TECHNOLOGY

BL
MOTOR

NIEUW



DLM536Z



DLM533Z

		DLM536Z	DLM533Z
Spanning		2x 18V	2x 18V
Bijgeleverde lader		-	-
Bijgeleverde accu's		-	-
Max. uitgangsvermogen		1600 W	1600 W
Maibreedte		53 cm	53 cm
Aanbevolen terreinoppervlakte		1600 - 1800 m ²	1600 - 1800 m ²
Chassis		Staal	Aluminium
Zelftrekkend		✓	✓
Inhoud opvangbak		60 l	60 l
Mulching		✓	✓
Gewicht		39,0 - 42,8 kg	39,0 - 42,8 kg
Prijs in €	excl. btw		
	incl. btw		

LM001G / LM002G

ACCU GRASMAAIERS 40VMAX

XGT

XGT
40Vmax

SOFT
NO LOAD

WG
WET GUARD

BL
MOTOR

3 snelheden: standaard, stil en automatisch (soft no load).

Nieuwe krachtige BL-motor met buitenrotor, speciaal ontwikkeld voor grasmaaiers.

Voeding met twee XGT accu's in parallel (36V). Automatische overschakeling wanneer één accu leeg is

Grote wielen Ø 230 mm voor betere tractie en comfortabel rijden op oneffen terrein.

Robuust stalen maaidek

Traploos regelbare snelheid met groot bereik (0,5 tot 1,5 km/h).

Stevige duwhendel opvouwbaar zonder gereedschap.

Grote opvangcapaciteit. Standaard met mulching plug en een plug voor grasuitworp achteraan.

Wetguard/IPX/4 compatibel Constructie met uitstekende bestendigheid tegen indringing van water.

Het standaard mes is geschikt voor mulchen en grasopvang. Speciale maaimessen zijn afzonderlijk verkrijgbaar

NIEUW

NIEUW

		LM001GZ	LM002GZ
Spanning		36 V (40Vmax)	36 V (40Vmax)
Max. uitgangsvermogen		1900 W	1900 W
Maibreedte		48 cm	53 cm
Aanbevolen terreinoppervlakte		1600 - 1800 m ²	1700 - 2000 m ²
Toerental onbelast		2500 / 3200 min ⁻¹	2300 / 2800 min ⁻¹
Maaihoogte		20 - 100 mm	20 - 100 mm
Rijsnelheid		1,5 - 5,0 km/h	1,5 - 5,0 km/h
Opvangcapaciteit		62 l	70 l
Gewicht		28,0 - 33,0 kg	29,5 - 34,7 kg
Prijs in €	excl. btw		
	incl. btw		

LM001C

GRASMAAIER MET RECHTSTREEKSE VOEDING VIA ACCUPACK



3 INSTELLINGEN :
- STANDAARD
- SOFT NO LOAD
- STILLE WERKING



LM001CZ



ENERGIEZUINIG MESONTWERP (onderkant toestel)

BL
MOTOR

XPT
EXTREME PROTECTION TECHNOLOGY

SOFT
NO LOAD



LM001C MET MONTAGE VAN PDC01 / PDC1200 (Draagbaar accupack niet inbegrepen)

		LM001CZ
Platform		Accupack
Max. uitgangsvermogen		1600 W
Maai breedte		53 cm
Maai hoogte		20 - 100 mm
Inhoud opvangbak		70 l
Mulching		✓
Zelftrekkend		✓
Chassis		Staal
Aanbevolen oppervlakte		1500 - 3000 m ²
Gewicht		41,9 kg
Prijs in €	excl. btw	
	incl. btw	

ACCESSOIRES BIJ DRAAGBAAR ACCUPACK

Adapter:
ref. 191N62-4



Niet alleen voor gebruik met machines met directe aansluiting

Adapter:
ref. 191J51-5



Ook standaard machines die werken met 40Vmax, 2 x 18V of 18V accu's kunnen op het accupack aangesloten worden middels de juiste adapter.

Adapter:
ref. 191J50-7



PDC1200

met geïntegreerde accu voor 36V/40Vmax

PDC01

kan tot 4 18V accu's bevatten



Werkt uitsluitend met Makita's draagbare accupack

UV3200 / UV3600

ELEKTRISCHE VERTICUTEERMACHINES

UV3200



UV3600



		UV3200	UV3600
Nominaal vermogen		1300 W	1800 W
Werkbreedte		32 cm	36 cm
Polypropyleen chassis		✓	✓
Gewicht		15 kg	18,3 kg
Prijs in €	excl. btw		
	incl. btw		



**DUH523 /
DUH507 /
DUH607 /
DUH551 /
DUH506 /
DUH606**

ACCU HEGGEN-
SCHAREN

		NIEUW		NIEUW		NIEUW		NIEUW	
		DUH523Z	DUH523RFE	DUH507Z	DUH507F001	DUH607Z	DUH607F001	DUH551Z	
Spanning		18V	18V	18V	18V	18V	18V	2 x 18V	
Bijgeleverde accu's		-	2 x accu 3,0 Ah	-	1x accu 3,0 Ah	-	1x accu 3,0 Ah	-	
Bijgeleverde lader		-	DC18RC	-	DC18WC	-	DC18WC	-	
BL motor		-	-	-	-	-	-	-	
Snijlengte		52 cm	52 cm	50 cm	50 cm	60 cm	60 cm	55 cm	
Maximale takdikte		15 mm	15 mm	15 mm	15 mm	15 mm	15 mm	18 mm	
Aantal snijbewegingen		2700 min ⁻¹	2700 min ⁻¹	2700 min ⁻¹	2700 min ⁻¹	2700 min ⁻¹	2700 min ⁻¹	2000-3600 min ⁻¹	
Max. uitgangsvermogen		210 W	210 W	250 W	250 W	250 W	250 W	320 W	
Gewicht		3,2 kg	3,2 kg	2,7 - 3,0 kg	2,7 - 3,0 kg	2,8 - 3,1 kg	2,8 - 3,1 kg	4,1 kg	
Prijs in €	excl. btw								
	incl. btw								



DUH523RFE



DUH551Z



DUH607Z



DUH606RF

		NIEUW		NIEUW		NIEUW	
		DUH506Z	DUH506RF	DUH606Z	DUH606RF	DUH606RF	
Spanning		18V	18V	18V	18V	18V	
Bijgeleverde accu's		-	1x accu 3,0 Ah	-	-	1x accu 3,0 Ah	
Bijgeleverde lader		-	DC18RC	-	-	DC18RC	
BL motor		✓	✓	✓	✓	✓	
Snijlengte		50 cm	50 cm	60 cm	60 cm	60 cm	
Max. takdikte		20 mm	20 mm	20 mm	20 mm	20 mm	
Aantal snijbewegingen		4000 min ⁻¹	4000 min ⁻¹	4000 min ⁻¹	4000 min ⁻¹	4000 min ⁻¹	
Max. uitgangsvermogen		320 W	320 W	320 W	320 W	320 W	
Gewicht		2,5 - 2,9 kg	2,5 - 2,9 kg	2,7 - 3,0 kg	2,7 - 3,0 kg	2,7 - 3,0 kg	
Prijs in €	excl. btw						
	incl. btw						



**DUH502 /
DUH602 /
DUH752 /
DUH501 /
DUH601 /
DUH751 /
DUH754S**

ACCU HEGGEN-
SCHAREN 18V



DUH754SZ
(ENKELZIJDIG MES)



DUH501RTE



DUH502RT

		DUH502Z	DUH502RT	DUH602Z	DUH602RT	DUH752Z	DUH752RT
Spanning		18V	18V	18V	18V	18V	18V
Bijgeleverde accu's		-	1 x accu 5,0 Ah	-	1 x accu 5,0 Ah	-	1 x accu 5,0 Ah
Bijgeleverde lader		-	1 x DC18RC	-	1 x DC18RC	-	1 x DC18RC
BL motor		✓	✓	✓	✓	✓	✓
Snijlengte		50 cm	50 cm	60 cm	60 cm	75 cm	75 cm
Max. takdikte		21,5 mm	21,5 mm	21,5 mm	21,5 mm	21,5 mm	21,5 mm
Aantal snijbewegingen		2000 / 3600 / 4400 min ⁻¹	2000 / 3600 / 4400 min ⁻¹	2000 / 3600 / 4400 min ⁻¹	2000 / 3600 / 4400 min ⁻¹	2000 / 3600 / 4400 min ⁻¹	2000 / 3600 / 4400 min ⁻¹
Max. uitgangsvermogen		520 W	520 W	520 W	520 W	520 W	520 W
Gewicht		3,8 kg	3,8 kg	3,8 kg	3,8 kg	3,8 kg	3,8 kg
Prijs in €	excl. btw						
	incl. btw						

		DUH501Z	DUH501RTE	DUH601Z	DUH601PTE	DUH751Z	DUH751PTE	DUH754SZ
Uitvoering		Trim	Trim	Trim	Trim	Trim	Trim	Trim
Mes		Dubbelzijdig	Dubbelzijdig	Dubbelzijdig	Dubbelzijdig	Dubbelzijdig	Dubbelzijdig	Enkelzijdig
Bijgeleverde accu's		-	2 x accu 5,0 Ah	-	2 x accu 5,0 Ah	--	2 x accu 5,0 Ah	-
Bijgeleverde Lader		-	1 x DC18RC	-	1 x DC18RD	-	1 x DC18RD	-
BL motor		✓	✓	✓	✓	✓	✓	✓
Aantal snijbewegingen		2000/3600/4400 min ⁻¹	2000/3600/4400 min ⁻¹	2000/3600/4400 min ⁻¹	2000/3600/4400 min ⁻¹	2000/3600/4400 min ⁻¹	2000/3600/4400 min ⁻¹	2000/3600/4400 min ⁻¹
Snijlengte		50 cm	50 cm	60 cm	60 cm	75 cm	75 cm	75 cm
Max. takdikte		23,5 mm	23,5 mm	23,5 mm	23,5 mm	23,5 mm	23,5 mm	23,5 mm
Max. uitgangsvermogen		520 W	520 W	520 W	520 W	520 W	520 W	520 W
Gewicht		3,8 - 4,5 kg	3,8 - 4,5 kg	3,8 - 4,5 kg	3,8 - 4,5 kg	3,8 - 4,5 kg	3,8 - 4,5 kg	3,4 - 3,9 kg
Prijs in €	excl. btw							
	incl. btw							

UH004G / UH005G

ACCU HEGGENSCHAREN
40VMAX 'TRIMVERSIE'



UH004GM201

PROMO

gratis AS001GZ na online registratie UH004GM201 & UH005GM201



	UH004GZ	UH004GM201	UH005GZ	UH005GM201
Uitvoering	Trim	Trim	Trim	Trim
Mes	Dubbelzijdig	Dubbelzijdig	Dubbelzijdig	Dubbelzijdig
Bijgeleverde accu's	-	2x BL4040	-	2x BL4040
Bijgeleverde lader	-	DC40RA	-	DC40RA
Aantal snijbewegingen	2000/3600/ 5000 min ⁻¹	2000/3600/ 5000 min ⁻¹	2000/3600/ 5000 min ⁻¹	2000/3600/ 5000 min ⁻¹
Snijlengte	60 cm	60 cm	75 cm	75 cm
Max. takdikte	23,5 mm	23,5 mm	23,5 mm	23,5 mm
Max. uitgangsvermogen	720 W	720 W	720 W	720 W
Gewicht	4,3 - 4,9 kg	4,3 - 4,9 kg	4,5 - 5,1 kg	4,5 - 5,1 kg
Prijs in €	excl. btw			
	incl. btw			

UH006G / UH007G

ACCU HEGGENSCHAREN 40VMAX
'TERUGSNOEIVERSIE'



UH006GM201

PROMO

gratis AS001GZ na online registratie UH006GM201 & UH007GM201



	UH006GZ	UH006GM201	UH007GZ	UH007GM201
Uitvoering	Terugsnoei	Terugsnoei	Terugsnoei	Terugsnoei
Mes	Dubbelzijdig	Dubbelzijdig	Dubbelzijdig	Dubbelzijdig
Bijgeleverde accu's	-	2x BL4040	-	2x BL4040
Bijgeleverde lader	-	DC40RA	-	DC40RA
Aantal snijbewegingen	2000/3000/ 4000 min ⁻¹	2000/3000/ 4000 min ⁻¹	2000/3000/ 4000 min ⁻¹	2000/3000/ 4000 min ⁻¹
Snijlengte	60 cm	60 cm	75 cm	75 cm
Max. takdikte	25 mm	25 mm	25 mm	25 mm
Max. uitgangsvermogen	720 W	720 W	720 W	720 W
Gewicht	4,4 - 5,0 kg	4,4 - 5,0 kg	4,6 - 5,2 kg	4,6 - 5,2 kg
Prijs in €	excl. btw			
	incl. btw			

UM600D / DUM111 / DUM604

ACCU GRAS- EN HEGGENSCHAAR

PROMO

Gratis werkhandschoenen maat L (P-84470)



DUM604RFEX

DUM111SYX

	UM600DSAEX	DUM111SYX	DUM604RFEX	DUM604ZX
Spanning	10,8 V (12Vmax)	18 V	18 V	18 V
Bijgeleverde accu's	2 x accu 2,0 Ah	1 x accu 1,5 Ah	2 x accu 3,0 Ah	-
Lader	DC10SB	DC18SD	DC18RC	-
Snijlengte heggenschaar	20 cm	20 cm	20 cm	20 cm
Snijbreedte grasschaar	16 cm	11 cm	16 cm	16 cm
Maximale takdikte	8 mm			
Geleverd met	Grasschaar + Heggenschaar	Grasschaar + Heggenschaar	Grasschaar + Heggenschaar	Grasschaar + Heggenschaar
Gewicht	1,2 kg	1,8 kg	1,8 kg	1,8 kg
Prijs in €	excl. btw			
	incl. btw			

UN460W / DUN461 / DUN500

ACCU STOKHEGGENSCHAREN



DUN500WZ

DUN461WST

	UN460WDZ	UN460WDWA	DUN461WZ	DUN461WST	DUN500WZ
Accuplatform	12Vmax (CXT)	12Vmax (CXT)	18 V (LXT)	18 V (LXT)	18 V (LXT)
Bijgeleverde accu's	-	1 x accu 2,0 Ah	-	1 x accu 5,0 Ah	-
Bijgeleverde lader	-	DC10WD	-	DC18SD	-
Snijlengte	46 cm	46 cm	46 cm	46 cm	50 cm
Maximale takdikte	18 mm	18 mm	18 mm	18 mm	23,5 mm
Totale lengte	1,889 - 2,511 mm	1,889 - 2,511 mm	1,889 - 2,511 mm	1,889 - 2,511 mm	2,115 mm
BL motor	-	-	-	-	✓
Aantal snijbewegingen	3600 min ⁻¹	3600 min ⁻¹	3600 min ⁻¹	3600 min ⁻¹	2000/3600/ 4400 min ⁻¹
Omkeerfunctie	✓	✓	✓	✓	✓
Gewicht	2,8 - 3,0 kg	2,8 - 3,0 kg	3,0 - 3,3 kg	3,4 kg	3,9 - 4,3 kg
Prijs in €	excl. btw				
	incl. btw				

UB101D

ACCU BLAZER 12VMAX



UB101DZ

Spanning	10,8 V (12Vmax)
Bijgeleverde accu's	-
Bijgeleverde lader	-
Luchtsnelheid	65 m/s
Max. debiet	2,6 m³/min
Max. blaaskracht	1,6 N
Gewicht	1,4 - 1,9 kg
Prijs in €	excl. btw
	incl. btw

DUB186

ACCU BLAZER 18V

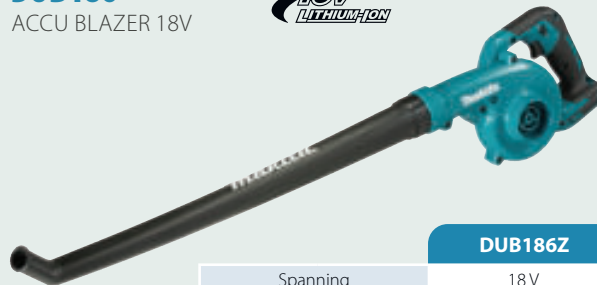

DUB186Z

Spanning	18 V
Bijgeleverde accu's	-
Bijgeleverde lader	-
Luchtsnelheid	56 m/s
Max. debiet	3,2 m³/min
Max. blaaskracht	2,5 N
Gewicht	1,6 - 2,1 kg
Prijs in €	excl. btw
	incl. btw

DUB184

ACCU BLADBLAZER 18 V



DUB184Z

DUB184RT

Spanning	18V	18V
Bijgeleverde accu's	-	1 x BL1850B
Bijgeleverde lader	-	DC18RC
Luchtsnelheid	49 m/s	49 m/s
Max. debiet	12,7 m³/min	12,7 m³/min
Max. blaaskracht	10,9 N	10,9 N
Gewicht	2,5 - 3,0 kg	2,5 - 3,0 kg
Prijs in €	excl. btw	
	incl. btw	

DUB362

ACCU BLADBLAZER 2 x 18 V



DUB362Z

DUB362TX1

Spanning	2x18V	18V
Bijgeleverde accu's	-	4 x BL1850B
Bijgeleverde lader	-	DC18RC
Luchtsnelheid	54 m/s	54 m/s
Max. debiet	13,4 m³/min	13,4 m³/min
Max. blaaskracht	14,4 N	14,4 N
Gewicht	3,5 - 4,2 kg	3,5 - 4,2 kg
Prijs in €	excl. btw	
	incl. btw	

UB001G

ACCU BLADBLAZER 40VMAX



PROMO

gratis AS001GZ na online registratie UB001GM101



UB001GZ

UB001GM101

Spanning	36V (40Vmax)	36V (40Vmax)
Bijgeleverde accu's	-	1 x BL4040
Bijgeleverde lader	-	DC40RA
Luchtsnelheid	64 m/s	64 m/s
Max. debiet	16,0 m³/min	16,0 m³/min
Max. blaaskracht	12 N (17 N boost)	12 N (17 N boost)
Gewicht	3,1 - 3,9 kg	3,1 - 3,9 kg
Prijs in €	excl. btw	
	incl. btw	

DUB363

ACCU BLADBLAZER / -ZUIGER 2 x 18 V



Geleverd met bladzuigset

DUB363Z

Spanning	2 x 18V
Bijgeleverde accu's	-
Bijgeleverde lader	-
Luchtsnelheid	54 m/s
Max. debiet	13,4 m³/min
Max. blaaskracht	14,4 N
Gewicht	4,5 - 6,6 kg
Prijs in €	excl. btw
	incl. btw

DUB187

ACCU BLADBLAZER / - ZUIGER 18V



- Budgetvriendelijke bladzuiger / blazer
- Variabele snelheid en "cruise control" (aanhouden gekozen snelheid)
- Turbine met verhakselmes
- Omschakelen van zuigen naar blazen met slechts één hendel

DUB187T001



NIEUW

NIEUW

DUB187Z

DUB187T001

Spanning	18V	18V
Bijgeleverde accu's	-	BL1850B
Bijgeleverde lader	-	DC18WC
Luchtsnelheid (blazen)	64 m/s	64 m/s
Max. debiet (zuigen)	6,1 m ³ /min	6,1 m ³ /min
Max. onderdruk	33 mbar	33 mbar
Max. blaaskracht	4,2 N	4,2 N
Gewicht	3,7 - 4,0 kg	3,7 - 4,0 kg
Prijs in €	excl. btw	
	incl. btw	

Optioneel accessoire

GB00000165

T-vormig mondstuk geschikt voor DUB187



UB001CZ

BLADBLAZER MET DIRECTE AANSLUITING OP ACCUPACK



ENKEL AANSLUITBAAR OP DRAAGBAAR ACCUPACK PDC/01 / PDC12000

HERTEKENDE LUCHTSTROOM VOOR BETERE PRESTATIES EN MEER GEBRUIKSGEMAK

LAAG GELUIDSNIVEAU

LAAG GEWICHT



UB001CZ

Platform	Accupack PDC01 of PDF1200
Max. luchtsnelheid	70 m/s
Max. debiet	17,6 m ³ /min
Max. blaaskracht	15 N (20 N boost)
Gewicht	2,6 kg
Prijs in €	excl. btw
	incl. btw

UB002CZ

RUGGEDRAGEN BLADBLAZER MET AANSLUITING VOOR ACCUPACK



ACCU NIET INBEGREPEN !

UB002CZ

Platform	Accupack PDC1200
Luchtsnelheid	71,7 m/s
Max. debiet	19 m ³ /min
Max. blaaskracht	20 N (22 N boost)
Geluidsdrukkniveau	81 dB (A)
Gewicht	15,9 - 16,1 kg
Prijs in €	excl. btw
	incl. btw



Het accupack kan in één beweging op de machine vastgeklikt worden.



Triggerschakelaar met variabele snelheid en "cruise control" hendel.



De bedieningshendel kan horizontaal verschoven en gekanteld worden.



DUX18

ACCU COMBISYSTEEM 18 V

PROMO

Gratis blazeropzetstuk
191F65-0 bij DUX18Z



DUX18Z

		DUX18Z	DUX18ZX1
Platform		LXT 18 V	LXT 18 V
Max. afgegeven vermogen		470 W	470 W
Toerental onbelast		0 - 6800 / 0 - 9700 min ⁻¹	0 - 6800 / 0 - 9700 min ⁻¹
Bijgeleverde accessoires		-	EM408MP
Bijgeleverde accu's / laders		-	-
Prijs in €	excl. btw		
	incl. btw		

DUX60

ACCU COMBISYSTEEM
2 x 18 V



PROMO

Gratis blazeropzetstuk
191F65-0 bij DUX60Z



DUX60Z

	DUX60Z	DUX60ZN1	DUX60ZM4	DUX60ZX8
Platform	LXT 2 x 18 V	LXT 2 x 18 V	LXT 2 x 18 V	LXT 2 x 18 V
Max. afgegeven vermogen	600 W	600 W	600 W	600 W
Toerental onbelast	0 - 5700 / 0 - 8200 / 0 - 9700 min ⁻¹	0 - 5700 / 0 - 8200 / 0 - 9700 min ⁻¹	0 - 5700 / 0 - 8200 / 0 - 9700 min ⁻¹	0 - 5700 / 0 - 8200 / 0 - 9700 min ⁻¹
Bijgeleverde accessoires	-	EN401MP	EM404MP	EN401MP EM404MP
Bijgeleverde accu's / laders	-	-	-	-
Prijs in €	excl. btw			
	incl. btw			

COMBISYSTEEM OPZETSTUKKEN

Artikel	Referentie	Ø (mm)	Prijs excl. btw	Prijs incl. btw
BOSMAAIER (Voor DUX18 enkel EM408MP geschikt)				
EM404MP	198768-1	450 mm		
EM401MP	195888-2	300 mm		
EM400MP	195648-2	420 mm		
EM406MP	198779-6	420 mm		
EM408MP	191N31-5	300 mm		
ROTORSCHAAR				
EM407MP	191M56-3			
GRASTRIMMER				
ER400MP	195522-4	410 mm		
SNOEIKETTINGZAAG				
EY403MP	191T38-7			
STOKHEGGENSCHAAR				
EN401MP	196256-2			
EN410MP	197726-4			
GRONDFREES				
KR400MP	199181-6			
BOORDENSNIJDER				
EE400MP	196752-0			
VERLENGSTUK				
LE400MP	191E24-8			
ROLVEGER				
SW400MP	199339-7			
ROLBORSTEL				
BR400MP	199318-5			
BLAZER				
UB400MP	191F65-0			
NIEUW	UB401MP	191P72-3		
NIEUW	UB402MP	1912R8-4		
WATERPOMP				
NIEUW	PF400MP	DEAPF400MP		

UX01GZ

ACCU COMBISYSTEEM 40VMAX



PROMO

Gratis blazeropzetstuk
191F65-0 bij UX01GZ



	UX01GZ	UX01GZ01
Platform	XGT 40Vmax	XGT 40Vmax
Max. afgegeven vermogen	1000 W	1000 W
Toerental onbelast	0 - 5700 / 0 - 8200 / 0 - 9700 min ⁻¹	0 - 5700 / 0 - 8200 / 0 - 9700 min ⁻¹
Bijgeleverde accessoires	-	EM404MP
Bijgeleverde accu's / laders	-	-
Prijs in €	excl. btw	
	incl. btw	



DUR193

ACCU GRASTRIMMER 18V



DUR193RF

	NIEUW	
	DUR193Z	DUR193RF
Spanning	18 V	18 V
Bijgeleverde accu's	-	1 x accu 3,0 Ah
Bijgeleverde lader	-	DC18RC
Snelheden	1	1
BL motor	-	-
ADT	-	-
AFT	-	-
Handgreep	Rond ("D")	Rond ("D")
Schacht	Telescopisch	Telescopisch
Max. uitgangsvermogen	280 W	280 W
Gewicht	2,3 - 2,6 kg	2,3 - 2,6 kg
Prijs in €	excl. btw	
	incl. btw	



DUR192, DUR194, DUR190 / DUR191 / DUR189

ACCU GRASTRIMMERS 18 V

PROMO

Gratis DMR057 bij DUR189RFE na online registratie

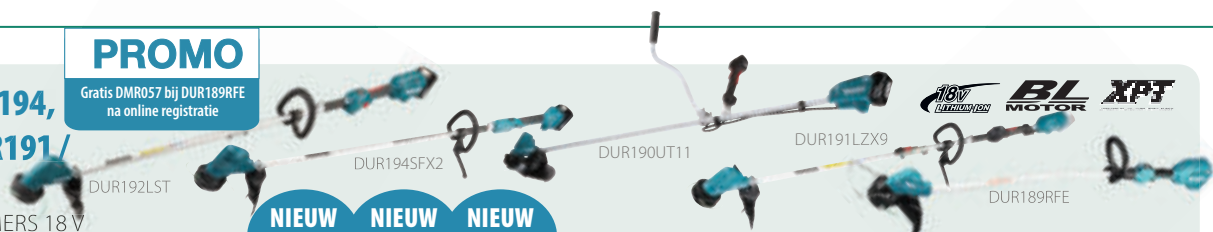

	DUR192LZ	DUR192LST	DUR194ZX3	DUR194SFX2	DUR194RTX1	DUR190LZX3	DUR190UZ9	DUR190UT11	DUR191LZX3	DUR191LZX9	DUR189Z	DUR189RFE
Spanning	18V	18V	18 V	18 V	18 V	18V	18V	18V	18V	18V	18V	18V
Bijgeleverde accu's	-	1 x accu 5,0 Ah	-	1x accu 3,0 Ah	1x accu 5,0 Ah	-	-	1 x accu 5,0 Ah	-	-	-	2x accu 3,0 Ah
Lader	-	DC18SD	-	DC18SD	DC18RC	-	-	DC18SD	-	-	-	DC18RC
Snelheden	2	2	2	2	2	3	3	3	3	3	3	3
BL motor	-	-	-	-	-	-	-	-	-	-	-	-
ADT	-	-	-	-	-	-	-	✓	✓	✓	✓	✓
AFT	-	-	-	-	-	-	-	✓	✓	✓	-	-
Handgreepvorm	D	D	D	D	D	D	U	U	D	D	D	D
Max. uitgangsvermogen	460 W	460 W	230 W	230 W	230 W	240 W	240 W	240 W	240 W	240 W	240 W	240 W
Gewicht	3,4 kg	3,4 kg	2,6 - 2,9 kg	2,6 - 2,9 kg	2,6 - 2,9 kg	2,7 kg	3,4 kg	3,1 kg	3,1 kg	3,1 kg	3,0 - 3,3 kg	3,0 - 3,3 kg
Prijs in €	excl. btw											
	incl. btw											

DUR368 / DUR369

ACCU BOSMAAIERS 2X18V

PROMO

Gratis BL1850B na online registratie



DUR369AZ

DUR368LZ

	DUR368LZ	DUR368AZ	DUR369AZ
Spanning	2x 18V	2x 18V	2x 18V
Max. toerental onbelast	6500 t.p.m.	6500 t.p.m.	7000 t.p.m.
Bijgeleverde accu's	-	-	-
Bijgeleverde lader	-	-	-
Snelheden	3	3	3
ADT	✓	✓	✓
AFT	✓	✓	✓
Handgreep	Rond ("D")	Beugel ("U")	Beugel ("U")
Max. uitgangsvermogen	550 W	550 W	1000 W
Gewicht	3,9 - 4,5 kg	4,1 - 4,7 kg	5,9 - 6,5 kg
Prijs in €	excl. btw		
	incl. btw		

UR016G / UR017G

ACCU BOSMAAIERS 40VMAX



	NIEUW	NIEUW
	UR016GZ	UR017GZ
Spanning	36V (40Vmax)	36V (40Vmax)
Bijgeleverde accu's	-	-
Bijgeleverde lader	-	-
Toerental onbelast	3500/5300/ 6500 min ⁻¹	3500/5300/ 6500 min ⁻¹
Handgreepvorm	Beugel ("U")	Rond ("D")
ADT	✓	✓
AFT	✓	✓
Max. uitgangsvermogen	600 W	600 W
Gewicht	4,6 - 5,4 kg	4,2 - 4,8 kg
Prijs in €	excl. btw	
	incl. btw	

UR002G / UR006G / UR007G

ACCU BOSMAAIERS 40VMAX

PROMO

Gratis AS001GZ na online registratie UR006GM101



	UR002GZ01	UR006GZ02	UR006GM101	UR007GZ01
Spanning	36V (40Vmax)	36V (40Vmax)	36V (40Vmax)	36V (40Vmax)
Max. toerental onbelast	3500 - 5300 - 6500 min ⁻¹	4600 - 5500 - 7000 min ⁻¹	4600 - 5500 - 7000 min ⁻¹	4600 - 5500 - 7000 min ⁻¹
Snelheden	3 + auto	3 + auto	3 + auto	3 + auto
Handgreepvorm	Beugel ("U")	Beugel ("U")	Beugel ("U")	Rond ("D")
ADT	✓	✓	✓	✓
AFT	✓	✓	✓	✓
Bijgeleverde accu's	0	0	1 x BL4040	0
Bijgeleverde lader	0	0	DC40RA	0
Max. uitgangsvermogen	550 W	1 kW	1 kW	1 kW
Gewicht	4,6 - 5,3 kg	5,7 - 6,3 kg	5,7 - 6,3 kg	5,7 - 6,3 kg
Prijs in €	excl. btw			
	incl. btw			

UR013G / UR014G

ACCU BOSMAAIERS 40VMAX



- 8-polige BL-motor met hoog koppel en lager toerental
- Laag geluidsniveau
- UR013G: beugelgreep (gereedschapsloze verstelling), en "high torque mode". Deze versie is ook geschikt voor gebruik met zaagblad of hakselblad
- UR014G: met ronde greep, twee draairichtingen, enkel te gebruiken met nylonkop
- Gemakkelijk een constante snelheid aanhouden met de "Cruise control" hendel
- De "Torque boost mode" levert een maximaal koppel voor zware werkzaamheden

UR013GZ04



UR014GZ

	NIEUW	NIEUW
	UR013GZ04	UR014GZ
Spanning	36V (40Vmax)	36V (40Vmax)
Toerental onbelast	3500 - 6700 min ⁻¹	4000 - 5000 min ⁻¹
Bijgeleverde accu's	-	-
Bijgeleverde lader	-	-
Handgreepvorm	Beugel ("U")	Rond ("D")
ADT	-	-
AFT	✓	✓
Max. uitgangsvermogen	1500 W	1500 W
Gewicht	5,9 - 7,2 kg	5,5 - 6,7 kg
Prijs in €	excl. btw	
	incl. btw	

UR012G

ACCU BOSMAAIER 2 x 40VMAX

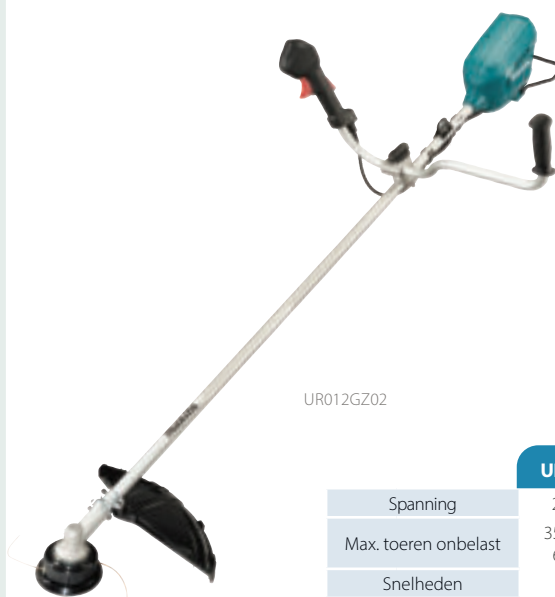

UR012GZ02

Uitgangsvermogen
2,0 kW

	UR012GZ02
Spanning	2 x 40Vmax
Max. toeren onbelast	3500 - 5000 - 6800 min ⁻¹
Snelheden	3 + auto
ADT	✓
AFT	✓
Bijgeleverde accu's	-
Bijgeleverde lader	-
Max. uitgangsvermogen	2,0 kW
Gewicht	8,0 - 9,3 kg
Prijs in €	excl. btw
	incl. btw

UC100D / DUC101 ACCUSNOEIZAGEN



DUC101SF

	NIEUW	NIEUW	NIEUW
	UC100DZ	DUC101Z	DUC101SF
Spanning	10,8V (12Vmax)	18V	18V
Bijgeleverde accu's	-	-	1x accu 3,0 Ah
Bijgeleverde lader	-	-	DC18SD
BL motor	✓	✓	✓
Snelspansysteem	✓	✓	✓
Zwaardlengte	100 mm	100 mm	100 mm
Ketting	80 TXL (0,325, 1,1 mm)	80 TXL (0,325, 1,1 mm)	80 TXL (0,325, 1,1 mm)
Kettingsnelheid	8 m/s	8 m/s	8 m/s
Gewicht	1,5-1,6 kg	1,6-2,0 kg	1,6-2,0 kg
Prijs in €	excl. btw		
	incl. btw		

DUC122 / DUC254 ACCUSNOEIKETTINGZAGEN 18V



DUC122RTE

DUC254Z001

OPGELET: voor het gebruik van een tophandle kettingzaag is een opleiding vereist. Raadpleeg steeds de veiligheidsvoorschriften.

	DUC122ZK	DUC122RTE	DUC254Z001
	Spanning	18V	18V
Bijgeleverde accu's	-	1 x accu 5,0 Ah	-
Bijgeleverde lader	-	DC18RC	-
BL motor	-	-	✓
Spansysteem	Snelspansysteem	Snelspansysteem	Geïntegreerde moeren
Zwaardlengte	11,5 cm	11,5 cm	25 cm
Ketting	025 (1/4", 1,3 mm)	025 (1/4", 1,3 mm)	80PX (0,325", 1,1 mm)
Kettingsnelheid	5 m/s	5 m/s	24 m/s
Gewicht	2,6 kg	2,6 kg	2,8 - 3,2 kg
Prijs in €	excl. btw		
	incl. btw		

DUC252 / -302 / -256 / -306 / -356 / -406 ACCUSNOEIKETTINGZAGEN 2 x 18V



DUC302Z

DUC256Z001

PROMO

gratis 87-delige gereedschapsset E-08458

XPT
DUC256
DUC306
DUC356
DUC406

	DUC252Z	DUC302Z	DUC256Z001	DUC306Z001	DUC356Z001	DUC406Z001
	Spanning	2x 18V	2x 18V	2x 18V	2x 18V	2x 18V
Bijgeleverde accu's	-	-	-	-	-	-
Bijgeleverde lader	-	-	-	-	-	-
BL motor	-	-	✓	✓	✓	✓
Snelspansysteem	✓	✓	-	-	-	-
Geïntegreerde moeren	-	-	✓	✓	✓	✓
Zwaardlengte	25 cm	30 cm	25 cm	30 cm	35 cm	40 cm
Ketting	092 (3/8", 1,3 mm)	092 (3/8", 1,3 mm)	80 TXL (0,325, 1,1 mm)	80 TXL (0,325, 1,1 mm)	80 TXL (0,325, 1,1 mm)	80 TXL (0,325, 1,1 mm)
Kettingsnelheid	8,3 m/s	8,3 m/s	20 m/s	20 m/s	20 m/s	20 m/s
Gewicht	4,1-4,7 kg	4,1-4,7 kg	4,6-5,1 kg	4,6-5,1 kg	4,6-5,1 kg	4,6-5,1 kg
Prijs in €	excl. btw					
	incl. btw					

UC002G / UC003G / UC004G / UC006G ACCUSNOEIKETTINGZAGEN 40VMAX



UC006GZ

UC003GM101

	UC002GZ	UC002GM101	UC003GZ	UC003GM101	UC004GZ	UC004GM101	UC006GZ
	Spanning	36V (40Vmax)	36V (40Vmax)	36V (40Vmax)	36V (40Vmax)	36V (40Vmax)	36V (40Vmax)
Bijgeleverde accu's	-	1x 4,0 Ah	-	1x 4,0 Ah	-	1x 4,0 Ah	-
Bijgeleverde lader	-	DC40RA	-	DC40RA	-	DC40RA	-
BL motor	✓	✓	✓	✓	✓	✓	✓
Geïntegreerde moeren	✓	✓	✓	✓	✓	✓	✓
Zwaardlengte	25 cm	25 cm	30 cm	30 cm	35 cm	35 cm	25 cm Carving
Ketting	90PX (3/8", 1,1 mm)	90PX (3/8", 1,1 mm)	90PX (3/8", 1,1 mm)	90PX (3/8", 1,1 mm)	90PX (3/8", 1,1 mm)	90PX (3/8", 1,1 mm)	90PX (1/4", 1,3 mm)
Kettingsnelheid	0 - 24,8 m/s	0 - 24,8 m/s	0 - 24,8 m/s	0 - 24,8 m/s	0 - 24,8 m/s	0 - 24,8 m/s	0 - 24,8 m/s
Gewicht	3,8 - 4,7 kg	3,8 - 4,7 kg	3,8 - 4,7 kg	3,8 - 4,7 kg	3,8 - 4,7 kg	3,8 - 4,7 kg	3,8 - 4,7 kg
Prijs in €	excl. btw						
	incl. btw						

DUC307 / DUC357

ACCU KETTINGZAGEN 18V



DUC357RTX2

	DUC307ZX2	DUC307RTX2	DUC357ZX2	DUC357RTX2
Spanning	18V	18V	18V	18V
Bijgeleverde accu's	-	1x 5,0 Ah	-	1x 5,0 Ah
Bijgeleverde lader	-	DC18RC	-	DC18RC
BL motor	✓	✓	✓	✓
Snelspansysteem	✓	✓	✓	✓
Zwaardlengte	30 cm	30 cm	35 cm	35 cm
Ketting	90PX (3/8", 1,1 mm)	90PX (3/8", 1,1 mm)	90PX (3/8", 1,1 mm)	90PX (3/8", 1,1 mm)
Kettingsnelheid	7,7 m/s	7,7 m/s	7,7 m/s	7,7 m/s
Gewicht	4,2 - 4,4 kg	4,2 - 4,4 kg	4,2 - 4,4 kg	4,2 - 4,4 kg
Prijs in €	excl. btw			
	incl. btw			

DUC353 / DUC405

ACCU KETTINGZAGEN 2 x 18V

18V → 36V



DUC405Z

PROMO

GRATIS ACCU 5,0 Ah na online registratie

	DUC353Z	DUC405Z
Spanning	2x 18V	2x 18V
Bijgeleverde accu's	-	-
Bijgeleverde lader	-	-
BL motor	✓	✓
Zwaardlengte	35 cm	40 cm
Bevestiging zwaard	Snelspansysteem	Geïntegreerde moeren
Ketting	90PX (3/8", 1,1 mm)	90PX (3/8", 1,1 mm)
Kettingsnelheid	20 m/s	20 m/s
Gewicht	4,6 - 5,5 kg	4,6 - 5,5 kg
Prijs in €	excl. btw	
	incl. btw	

UC010G / UC011G / UC012G / UC013G

ACCU KETTINGZAAG 40Vmax

WG WET GUARD **XCT** 40Vmax



UC012GT102

UC013GT102

HOOG VERMOGEN
HOGE KETTINGSNELHEID
REGEELBAAR OLIEDEBIET
LAAG TRILLINGSNIVEAU

PROMO

gratis AS001GZ na online registratie UC010GT101, UC011GT101, UC012GT102 & UC013GT102



	UC010GZ	UC010GT101	UC011GZ	UC011GT101	UC012GZ01	UC012GT102	UC013GZ01	UC013GT102
Spanning	36V (40Vmax)	36V (40Vmax)	36V (40Vmax)	36V (40Vmax)	36V (40Vmax)	36V (40Vmax)	36V (40Vmax)	36V (40Vmax)
Bijgeleverde accu's	-	1 x 5,0 Ah	-	1 x 5,0 Ah	-	1 x 5,0 Ah	-	1 x 5,0 Ah
Bijgeleverde lader	-	DC40RA	-	DC40RA	-	DC40RA	-	DC40RA
BL motor	✓	✓	✓	✓	✓	✓	✓	✓
Geïntegreerde moeren	✓	✓	✓	✓	✓	✓	✓	✓
Zwaardlengte	30 cm	30 cm	35 cm	35 cm	40 cm	40 cm	45 cm	45 cm
Ketting	80TXL (0,325, 1,1 mm)	80TXL (0,325, 1,1 mm)	80TXL (0,325, 1,1 mm)	80TXL (0,325, 1,1 mm)	3/8" 1,3 mm	3/8" 1,3 mm	3/8" 1,3 mm	3/8" 1,3 mm
Kettingsnelheid	0 - 25,5 m/s	0 - 25,5 m/s	0 - 25,5 m/s	0 - 25,5 m/s	0 - 25,5 m/s	0 - 25,5 m/s	0 - 25,5 m/s	0 - 25,5 m/s
Gewicht	6,1 - 7,4 kg	6,1 - 7,4 kg	6,1 - 7,4 kg	6,1 - 7,4 kg	6,1 - 7,4 kg	6,1 - 7,4 kg	6,1 - 7,4 kg	6,1 - 7,4 kg
Prijs in €	excl. btw							
	incl. btw							

DDG460

ACCU GRONDBOOR 2 x 18 V

LXT ADT BL MOTOR
XPT 18V + 18V → 36V



DDG460ZX7

	DDG460ZX7	DDG460TZX7
Spanning	2 x 18 V	
Bijgeleverde accu's	-	2x BL1850B
Bijgeleverde lader	-	DC18RD
Max. diameter boor	200 mm	
Max. koppel	136 Nm	
Toerental onbelast	0 - 350 min ⁻¹ 0 - 1400 min ⁻¹	0 - 350 min ⁻¹ 0 - 1400 min ⁻¹
Gewicht	7,3 - 8,2 kg	
Prijs in €	excl. btw	
	incl. btw	

DG001G

ACCU GRONDBOOR 40VMAX

WG ADT BL MOTOR XPT 40Vmax



DG001GM105

DG001GZ05 DG001GM105

PROMO

gratis AS001GZ na online registratie DG001GM105



	DG001GZ05	DG001GM105
Spanning	36V (40Vmax)	
Bijgeleverde accu's	-	1x BL4040
Bijgeleverde lader	-	DC40RA
Max. diameter boor	200 mm	
Max. koppel	136 Nm	
Toerental onbelast	0 - 350 min ⁻¹ 0 - 1400 min ⁻¹	0 - 350 min ⁻¹ 0 - 1400 min ⁻¹
Gewicht	7,2 - 8,1 kg	
Prijs in €	excl. btw	
	incl. btw	



Omkeerschakelaar

De draairichting kan omgekeerd worden om de boor los te maken wanneer ze geblokkeerd geraakt is of te diep vastzit in zware kleigrond.



Slipkoppeling

De slipkoppeling verbreekt de verbinding tussen de motor en de boor wanneer het koppel een extreme waarde overschrijdt. Dat voorkomt schade aan de machine en verhoogt de veiligheid voor de gebruiker.

Adapters



327687-6
Adapter Type D
voor Makita grondboren



327684-2
Adapter Type A
voor Stihl grondboren

Grondboren met hexagonale schacht



Artikel nr.	Diameter	Totale lengte	Nuttige lente	Prijs (excl. btw)	Prijs (incl. btw)
D-75415	Ø 30 mm	600 mm	200 mm		
D-75421	Ø 45 mm	600 mm	200 mm		
D-75437	Ø 70 mm	600 mm	200 mm		
D-75443	Ø 100 mm	600 mm	200 mm		
D-75459	Ø 130 mm	600 mm	200 mm		
E-17049	Ø 40 mm	600 mm	470 mm		

Grondboren te gebruiken met adapter (type D) incl. borgpen

Artikel nr.	Diameter	Totale lengte	Nuttige lengte	Prijs (excl. btw)	Prijs (incl. btw)
E-13611	Ø 50 mm	800 mm	550 mm		
E-13627	Ø 60 mm	800 mm	550 mm		
E-13633	Ø 80 mm	800 mm	550 mm		
E-07294	Ø 100 mm	800 mm	550 mm		
E-07303	Ø 150 mm	800 mm	550 mm		
E-07319	Ø 200 mm	800 mm	550 mm		

Vervangmesjes	Prijs (excl. btw)	Prijs (incl. btw)
E-13649		
E-13655		
E-13661		
E-07630		
E-07646		
E-07652		



E-07325
Verlengstuk
540 mm



E-07331
Borgpen



DCU180Z

ACCU KRUIWAGEN 18 V

PROMO

BUIZENFRAME
(199009-8) +
1 x ACCU 3 Ah +
lader DC18RC

18V
LITHIUM-ION

XPT
EXTREME PROTECTION TECHNOLOGY

BL
MOTOR

LXT



Elektronische
snelheidsregeling



Demonteerbare
achterwielen



Geïntegreerde
ledverlichting



DCU180Z

Spanning	18V
Type	Kantelbare kuip of vast plateau
Volume kuip	90 l
Max. lading op vlak terrein	130 kg
Max. helling	12°
Rijsnelheid vooruit	0-1,5 / 0-3,5 km/h
Rijsnelheid achteruit	1,0 km/u
Gewicht	39,3 kg
Prijs in €	excl. btw
	incl. btw

DCU603 / DCU604 / DCU605

ACCU KRUIWAGENS 2 x 18 V



- Aangedreven door 2 LXT-accu's in serie (36V) met plaats voor 4 accu's.
- Maximaal draagvermogen van 300 kg (180 kg op hellingen tot 12°).
- 3 versnellingen vooruit, één versnelling achteruit en variabele snelheidsregeling.
- Zwaar uitgevoerde vooras met differentieel.
- Schijfremmen, elektrische rem en elektromagnetische veiligheidsrem.
- Balancerende achteras biedt optimale stabiliteit, ook op oneffen terrein.
- Vrijloopstand (motor losgekoppeld van de wielen).
- In hoogte verstelbare handgreep.
- Verkrijgbaar in drie versies: met een kantelbare kuip (DCU603), met een kantelbaar frame (DCU604) en met een vaste vlakke kuip (DCU605)

	NIEUW DCU603Z	NIEUW DCU604Z	NIEUW DCU605Z
Spanning	2 x 18V	2 x 18V	2 x 18V
Type	Kantelbare kuip	Kantelbaar frame	Vaste kuip
Volume kuip	100 l	-	250 l
Max. lading vlak terrein	300 kg	300 kg	300 kg
Max. lading helling (3° - 12°)	180 kg	180 kg	180 kg
Rijsnelheid vooruit	1,5 - 3,5 - 5,0 km/u	1,5 - 3,5 - 5,0 km/u	1,5 - 3,5 - 5,0 km/u
Rijsnelheid achteruit	1,0 km/h	1,0 km/h	1,0 km/h
Gewicht	122 - 124 kg	122 - 124 kg	122 - 124 kg
Prijs in €	excl. btw		
	incl. btw		

PM001GZ01

ACCU RUGGEDRAGEN VERNEVELAAR



NIEUW

PM001GZ01

Spanning	36V (40Vmax)
Tankinhoud	15,0 l
Luchtdebiet	9,0 - 11,0 - 13,3 m ³ /min
Blaaskracht	6,0 - 9,5 - 15 N
Verstuifcapaciteit	500 - 1400 ml/min
Geluidsdruk	87 dB(A)
Gewicht	13,2 - 15,7 kg
Prijs in €	excl. btw
	incl. btw

- Voor het verstuiven van pesticiden of ontsmettingsmiddelen
- Werkt met twee accu's in parallel (met automatisch overschakelen)
- Drie vermogensstanden en variabele snelheidsregeling
- Standaard geleverd met twee sproeiers (standaard en laag volume)

US053DZ / DUS054Z

ACCU COMPACTE SPROEIER



UITSCHUIFBARE SPIJTLANS: 0,5 - 0,7 M

	US053DZ	DUS054Z
Spanning	10,8V (12Vmax)	18V
Bijgeleverde accu's	0	0
Tankinhoud	5 l	5 l
Debiet	0,2 l/min	0,2 l/min
Max. druk	2,6 bar	2,6 bar
Afmetingen	340 x 183 x 360 mm	340 x 183 x 360 mm
Gewicht	2,9 - 3,0 kg	3,2 - 3,5 kg
Prijs in €	excl. btw	
	incl. btw	

DUS054Z

DHW080ZK

ACCU HOGEDRUKREINIGER

18V + 18V → 36V

Capaciteit watertank

50 l

Werkdruk

30/55 bar

Debiet

4,0/5,5 l/min

Compatibel

Er is een breed assortiment aan hulpstukken beschikbaar, ze zijn ook compatibel met de HW1200 / HW1300.



DHW080ZK

Spanning	2 x 18V
Bijgeleverde accu's	-
Lader	-
Werkdruk (laag/hoog)	30/55 bar
Debiet (laag/hoog)	4,0/5,5 l/min
Inhoud watertank	50 l
Gewicht	7,1-7,7 kg
Prijs in €	excl. btw
	incl. btw

DUS108Z / DUS158Z

ACCU RUGSPROEIERS

18V LITHIUM-ION



DUS158Z



	DUS108Z	DUS158Z
Spanning	18V	18V
Bijgeleverde accu's	0	0
Tankinhoud	10 l	15 l
Debiet	0,8 - 1,3 l/min	0,8 - 1,3 l/min
Max. druk	3,0 bar	3,0 bar
Afmetingen	325 x 237 x 439 mm	325 x 237 x 517 mm
Gewicht	4,6 kg	4,6 kg
Prijs in €	excl. btw	
	incl. btw	

HW1200 / HW1300 / HW131 / HW151

ELEKTRISCHE HOGEDRUKREINIGERS



	HW1200	HW1300	HW131	HW151
Vermogen	1800 W	1800 W	2200 W	2500 W
Max. druk	120 bar	130 bar	130 bar	150 bar
Max. debiet	420 l/u	420 l/u	500 l/u	500 l/u
Haspel	10 m	10 m	15 m	10 m
Gewicht	11,0 kg	12,7 kg	33 kg	26,9 kg
Prijs in €	excl. btw			
	incl. btw			

PF0800 / PF1100

DOMPELPOMPEN VOOR ZUIVER WATER



PF0800

PF1010

PF1100

PF1110

PF1010 / PF1110

DOMPELPOMPEN VOOR VUIJL WATER

	PF0800	PF1010	PF1100	PF1110
Nominaal vermogen	800 W	1100 W	1100 W	1100 W
Max. debiet	220 l/min	240 l/min	250 l/min	250 l/min
Max. opvoerhoogte	9 m	10 m	9 m	10 m
Gewicht	6,1 kg	6,6 kg	6,7 kg	7,0 kg
Prijs in €	excl. btw			
	incl. btw			

EW1050HX

BENZINE SPROEIWATERPOMP

Tot einde voorraad



EW1050HX

EW1050HX

4-takt	✓
Cilinderinhoud	24,5 cc
Vermogen	1,0 pk / 0,71 kW
Max. aanzuighoogte	8 m
Max. opvoerhoogte	35 m
Max. debiet	110 l/min
Gewicht	5,8 kg
Prijs in €	excl. btw
	incl. btw

DUP362

ACCU SNOEISCHAAR 2 x 18 V



Inclusief
harnas & holster

DUP362Z

DUP362PT2

Bijgeleverde accu's	-	2 x accu 5,0 Ah
Bijgeleverde lader	-	DC18RD
Max. takdikte	33 mm	33 mm
Gewicht	3,3 kg	3,3 kg
Prijs in €	excl. btw	
	incl. btw	

UD2500

ELEKTRISCHE HAKSELAAR



UD2500

Nominaal vermogen	2500 W
Max. toerental onbelast	40 t.p.m
Max. takdikte	45 mm
Geluidsdruk	84 dB(A)
Gewicht	29,7 kg
Prijs in €	excl. btw
	incl. btw

UP100D

SNOEISCHAAR 12VMAX



NIEUW

UP100DSMJ

Spanning	10,8 V (12Vmax)
Bijgeleverde accu's	1x BL1041B
Bijgeleverde lader	DC10SB
Maximaal afgegeven vermogen	170 W
Snijcapaciteit	25 mm
Afmetingen (L x B x H)	259 x 53 x 98 mm
Gewicht	0,89 - 1,1 kg
Prijs in €	excl. btw
	incl. btw

DLX4181PT2

ACCU COMBOPACK TUIN

18V + 18V → 36V

18V LITHIUM-ION



DLX4181PT2

Bijgeleverde accu's	2 x accu 5,0 Ah
Duo snellader	DC18RD
Heggenschaar	DUH523
Bladblazer	DUB184
Grastrimmer	DUR193
Grasmaaier	DLM432
Prijs in €	excl. btw
	incl. btw

DLX5057PTJ

ACCU COMBOPACK TUIN

18V + 18V → 36V

XPT

BL MOTOR

18V LITHIUM-ION



DLX5057PTJ

Bijgeleverde accu's	4 x accu 5,0 Ah
Duo snellader	DC18RD
Heggenschaar	DUH601
Kettingzaag	DUC353
Grastrimmer	DUR368
Grasmaaier	DLM460
Bladblazer	DUB362
Prijs in €	excl. btw
	incl. btw



LXT

DUC405Z

DUR368LZ

DUC353Z

DUR369AZ

DUR368AZ

DUC405Z

PROMO
BL1850B

1 accu 5,0 Ah gratis na online registratie
Bij aankoop van een 2 x 18V machine

DLM463Z

DLM539CT2

DUR368AZ

DLM463PT2

DLM536Z

DLM537Z

DLM465Z

DLM539CT2

DLM465PT2

18v + 18v → 36v

Z-versies
geleverd zonder
batterijen of lader

Promo: gratis artikelen direct geleverd bij de machines

PROMO
191F65-0

UX01GZ

GRATIS
Blazer

PROMO
P-86470
(Mak-L)

UM600DSAEX

DUX600

DUM604RFEX

DUX60ZN1

UX01GZ

PROMO
E-08458



GRATIS
Gereedschapset



DUC252Z

DUC252Z

DUC302Z

DUC256Z

DUC356Z

DUC306Z001

DUC406Z001



GRATIS
Werkhandschoenen



DUM604ZX

LXT

Gratis promo na online registratie
Bij aankoop van een 40Vmax machine hieronder

PROMO
DMR857



GRATIS
Camping lamp
met radio en
Bluetooth

PROMO
A5001GZ

XGT



GRATIS
Blaas- en zuigmachine

UA004GM101

UR006GM101

UH004GM201

DUH501RTE



UA004GM101



UR006GM101

UH006GM201



DUH501RTE

UC003GM101

UC004GM101

UB001GM101

UB001GM101

UH007GM201

UH007GM201

DUR189RFE

UC002GM101

UC010GT101

UH007GM201

UH005GM201

DUR189RFE

UC011GT101



UC003GM001

UC012GT102

UC013GT102

DG001GM105

DG001GM105

UH014GM101

UH013GM101

UH007GM201

UH005GM201

Deze XGT machines
zijn geleverd met
batterij(en) en lader

XGT
40V Li-ION
max

Ontvang een gratis cadeau!

Van 01 januari 2023 t.e.m. 31 december 2023 kan u bij aankoop van de bovenstaande producten een gratis cadeau aanvragen! Voor de gratis producten na online registratie: surf naar www.makita.be en vul het formulier in dat u kan terug vinden in 'Mijn Makita'. Na ontvangst van de correcte gegevens sturen we het gratis product zo snel mogelijk naar u toe.

De actie is uitsluitend van toepassing op aankopen bij een officieel erkende Makitaverdeler. Deze kan u terugvinden in de dealerlocator op www.makita.be. De complete voorwaarden van deze actie zijn na te lezen op de actiepagina in 'Mijn Makita'. Actie niet cumuleerbaar met andere acties en niet van toepassing op machines die deel uitmaken van een combokit of een omruiling in het kader van een reparatie.

Makita

Makita®



www.makita.be



Jan-Baptist Vinkstraat 2
B-3070 Kortenberg



REF: PLFNL23

Geldig van 01/04/2023 t.e.m. 30/09/2023.

Afbeeldingen kunnen afwijken van het origineel. Technische gegevens en prijzen zijn indicatief en onder voorbehoud van drukfouten. Aanbevolen prijzen excl. bebāt en recupel. Registratienummer/milieubelasting: 400/0000042/81. Promoties geldig tot einde voorraad.



MIX
Papier van
verantwoorde herkomst
FSC® C003224